

025

**CHAIR
COMPONENTS**

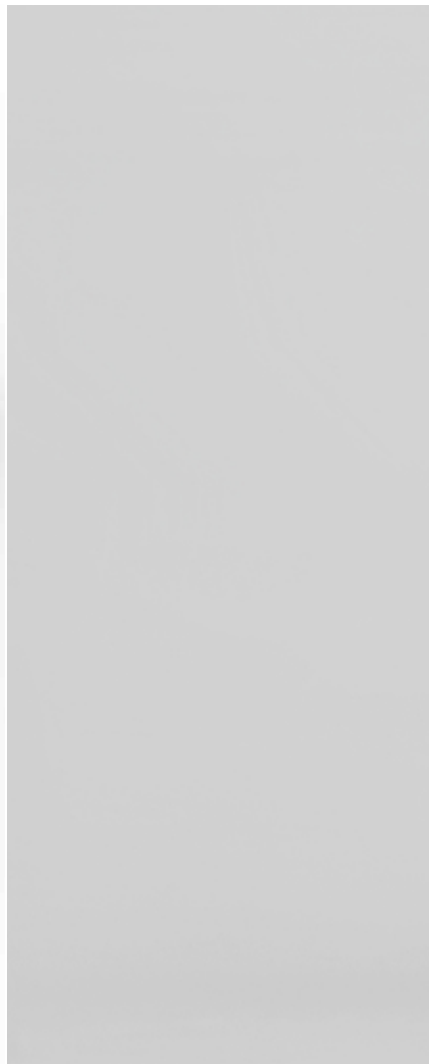

Your #NR 1 supplier of quality components for furniture and industry. **JUST ASK!**

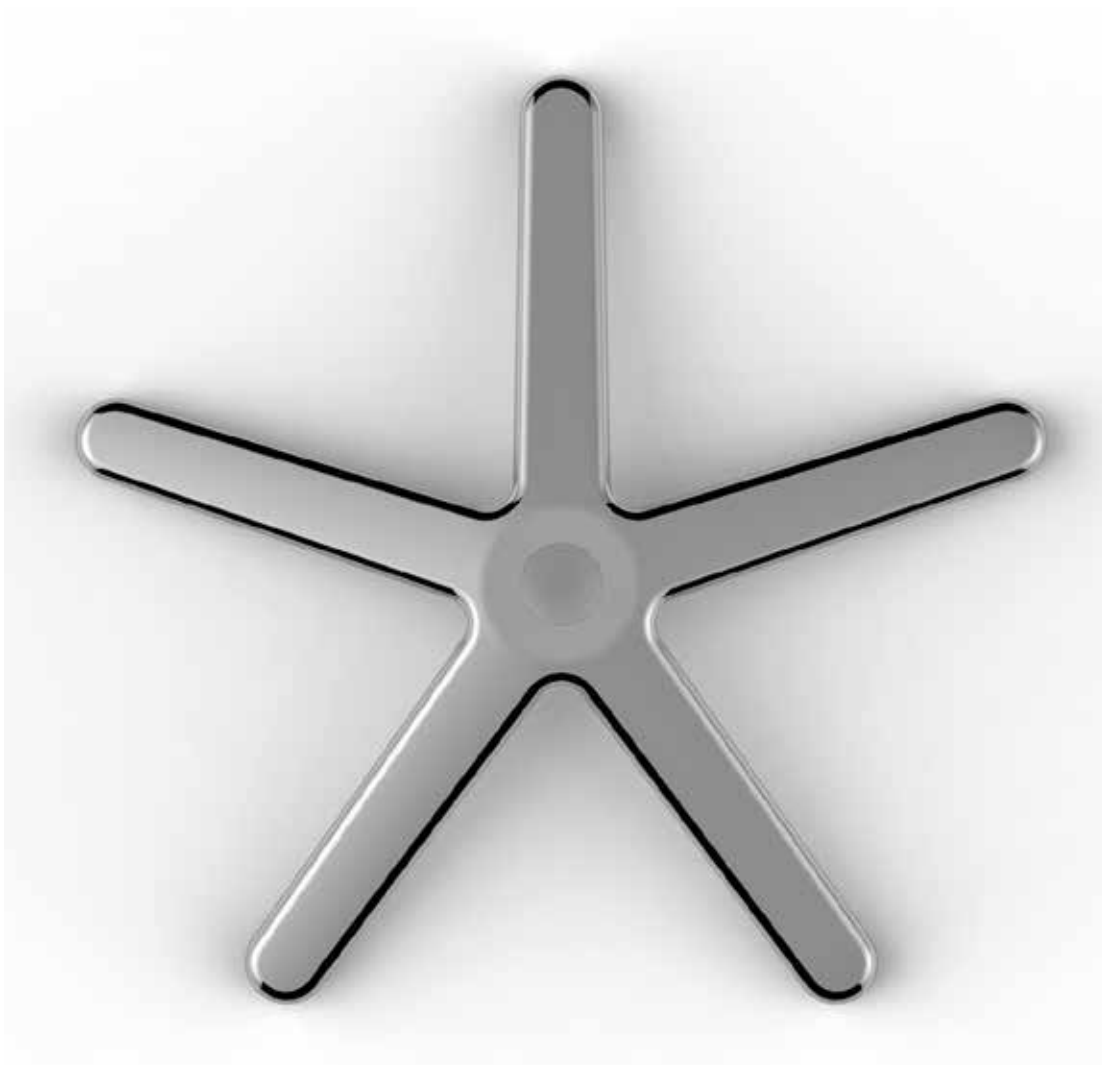



CHAIR COMPONENTS

CONTENTS

ALUMINIUM BASES	4	POLYURETHANE PARTS	110
ALUMINIUM/NYLON BASES	30	FOAM PARTS	136
NYLON BASES	36	UPHOLSTERED PARTS	164
FOOTRESTS	38	WOODEN PARTS	182
DISC BASES	44	POSITION & SUPPORT	186
GAS CYLINDERS	48	MIX & MATCH PU PARTS	132
CASTORS	60	MIX & MATCH FOAM PARTS	158
GLIDES	66	ABOUT ACP	188
MECHANISMS	68	GAS SPRINGS & DAMPERS	190
FLEXLINE	92		
ARMRESTS	100		

ALUMINIUM BASE

**A bold design,
seamless construction,
and lasting comfort**

IXION

DESIGNED BY DEMAND, PERFECTED FOR PERFORMANCE

Born from continued market demand, the IXION base is an exclusive product of our own in-house design, crafted with our customers' needs in mind. Its striking simplicity makes it a standout feature in any office setting. With a completely seamless profile and a beautifully flattened core, IXION blends aesthetics with strength. The solid construction ensures stability, providing a sense of ease and comfort in everyday use. A proven success since its launch - and for good reason.



ALUMINIUM BASE

IXION



ALUMINIUM BASE

IXION

SIZES

ø 520 mm
 ø 600 mm
 ø 660 mm
 ø 720 mm

BIFMA
 standard

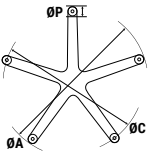

The IXION base was created in response to a strong market demand and is designed with customer needs in mind. Since its launch, the IXION has been a standout success. Its sleek, minimalist shape is both bold and captivating, with a seamless profile and a beautifully flattened core. The solid construction ensures stability and provides a sense of ease and comfort, making it a perfect blend of form and function.

- + unique design
- + no ribs
- + flat center
- + available in 4 sizes
- + polished or black aluminium (white or ppc on request)
- + BIFMA standard

	MATERIAL	FINISH	A	C	P	H	CONE	KG
IXION-520-AP	aluminium	polished	520	470	38	65	50	1,7
IXION-600-AP	aluminium	polished	600	550	38	65	50	2
IXION-660-AP	aluminium	polished	660	610	38	65	50	2,1
IXION-720-AP	aluminium	polished	720	670	38	65	50	2,7
IXION-520-AB	aluminium	black	520	470	38	65	50	1,7
IXION-600-AB	aluminium	black	600	550	38	65	50	2
IXION-660-AB	aluminium	black	660	610	38	65	50	2,1
IXION-720-AB	aluminium	black	720	670	38	65	50	2,7



NO RIBS

ALUMINIUM BASE

POLAR



ALUMINIUM BASE

POLAR

INNOVATION IN EVERY DETAIL

The POLAR base is a direct result of our dedicated in-house design team, committed to developing innovative solutions.

Developed to meet the demands of the modern office, it redefines stability and style. Unlike traditional bases with a tilt, POLAR features a fully flattened horizontal design.

Its perfectly aligned legs and castors create a sleek, sophisticated look, making it an eye-catching choice for executive and office chairs.

Available in four diameters, POLAR offers both versatility and a bold statement in workplace design.

**Precision-engineered,
perfectly balanced and
designed to stand out**

ALUMINIUM BASE

POLAR



ALUMINIUM BASE

POLAR

SIZES

ø 530 mm
 ø 610 mm
 ø 660 mm
 ø 700 mm

BIFMA
 standard

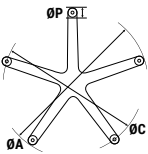

Our designers were challenged to create an innovative star base for the office market, and the result is the POLAR. Unlike regular bases that show a tilt, the POLAR is fully flattened horizontally. Its legs are perfectly aligned with the castors, giving it a sleek and sophisticated business look. A striking feature for any office or executive chair, the POLAR comes in four diameters, making it versatile and a true trendsetter.

- + modern design
- + also available as
Polar Solid (no ribs)
- + flat center
- + suitable for central
brake (610-660-700)
- + available in 4 sizes
- + polished or black
aluminium (white or
ppc on request)
- + BIFMA standard

	MATERIAL	FINISH	A	C	P	H	CONE	KG
POLAR-530-AP	aluminium	polished	530	508	23	50	50	1,5
POLAR-610-AP	aluminium	polished	610	588	23	50	50	1,6
POLAR-660-AP	aluminium	polished	660	638	23	50	50	1,8
POLAR-700-AP	aluminium	polished	700	678	23	50	50	2,1
POLAR-530-AB	aluminium	black	530	508	23	50	50	1,5
POLAR-610-AB	aluminium	black	610	588	23	50	50	1,6
POLAR-660-AB	aluminium	black	660	638	23	50	50	1,8
POLAR-700-AB	aluminium	black	700	678	23	50	50	2,1



ALUMINIUM BASE

POLAR SOLID



POLAR SOLID

UNCOMPROMISING STRENGTH AND CLEAN DESIGN

The POLAR SOLID is another exclusive design by our team, building on the success of the original POLAR series. This new base takes precision engineering a step further. Its fully flattened, rib-free design enhances both aesthetics and functionality, ensuring a clean, modern look. With a solid structure built for high-demand environments, it offers exceptional durability and easy maintenance – making it the ideal choice for workplaces where hygiene and strength are essential, from offices to healthcare settings.



**Seamless construction,
maximum durability, and
effortless maintenance**

ALUMINIUM BASE

POLAR SOLID

SIZES

ø 530 mm
 ø 610 mm
 ø 660 mm

BIFMA
 standard

The POLAR SOLID is a new addition to the popular POLAR series. Featuring a seamless, rib-free construction, this star base has a beautifully flattened core. Its solid structure makes it ideal for environments where hygiene is essential, such as healthcare settings.

- + unique design
- + 100% solid, no ribs
- + flat center
- + available in 3 sizes
- + polished aluminium
- + BIFMA standard

	MATERIAL	FINISH	A	C	P	H	CONE	KG
POLAR-S-530-AP	aluminium	polished	530	508	23	50	50	1,6
POLAR-S-610-AP	aluminium	polished	610	588	23	50	50	1,8
POLAR-S-660-AP	aluminium	polished	660	638	23	50	50	2

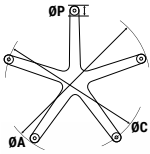

NO RIBS



ALUMINIUM BASE

POLAR WITH CENTRAL BRAKE

SIZES

ø 610 mm
ø 660 mm
ø 700 mm

BIFMA
standard

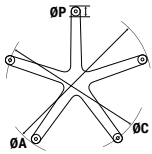

An ingenious addition to the POLAR base is a central brake. This foot-operated press-on, press-off braking system is activated by foot. Just press the foot pedal down to engage the brake and press the same pedal again to release the brake. This base is often used in healthcare environments and other settings where a stable and safe seating position is of the highest importance.

- + integrated central brake for total lock
- + 65 mm castors included
- + flat center
- + available in 3 sizes
- + polished or black aluminium
- + BIFMA standard

	MATERIAL	FINISH	A	C	P	H	CONE	KG
POLAR-REM-610-AP	aluminium	polished	610	588	23	50	50	5
POLAR-REM-660-AP	aluminium	polished	660	638	23	50	50	5,2
POLAR-REM-700-AP	aluminium	polished	700	678	23	50	50	5,5
POLAR-REM-610-AB	aluminium	black	610	588	23	50	50	5
POLAR-REM-660-AB	aluminium	black	660	638	23	50	50	5,2
POLAR-REM-700-AB	aluminium	black	700	678	23	50	50	5,5



ALUMINIUM BASE

DIADEM



ALUMINIUM BASE

DIADEM

SIZES

ø 530 mm
 ø 610 mm
 ø 670 mm
 ø 700 mm

BIFMA
 standard

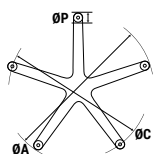

The DIADEM is a classic, low star base with rounded ends and sides, crafted from high-quality aluminium. Its timeless design ensures both elegance and stability, making it a versatile and stylish choice for any setting.

- + modern design
- + available in 4 sizes
- + polished or black aluminium (white or ppc on request)
- + BIFMA standard

	MATERIAL	FINISH	A	C	P	H	CONE	KG
DIADEM-530-AP	aluminium	polished	530	496	38	55	50	1,5
DIADEM-610-AP	aluminium	polished	610	572	38	55	50	1,6
DIADEM-670-AP	aluminium	polished	670	632	38	55	50	1,8
DIADEM-700-AP	aluminium	polished	700	662	38	55	50	1,9
DIADEM-530-AB	aluminium	black	530	496	38	55	50	1,5
DIADEM-610-AB	aluminium	black	610	572	38	55	50	1,6
DIADEM-670-AB	aluminium	black	670	632	38	55	50	1,8
DIADEM-700-AB	aluminium	black	700	662	38	55	50	1,9



ALUMINIUM BASE

LESATH



ALUMINIUM BASE

LESATH

SIZES

∅ 500 mm
∅ 610 mm

BIFMA
standard

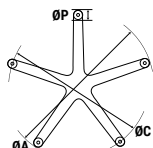

Like all other models, the LESATH is made of high-quality cast aluminium ADC12. Due to its small circumference and curved legs, the Lesath is suitable for use in tough conditions.

- + no nonsense design
- + small base: ideal solution for stools
- + available in 2 sizes
- + polished or black aluminium
- + BIFMA standard

	MATERIAL	FINISH	A	C	P	H	CONE	KG
LESATH-500-AP	aluminium	polished	500	462	38	60	50	1,2
LESATH-610-AP	aluminium	polished	610	572	38	75	50	1,7
LESATH-500-AB	aluminium	black	500	462	38	60	50	1,2
LESATH-610-AB	aluminium	black	610	572	38	75	50	1,7



ALUMINIUM BASE

MAIA



ALUMINIUM BASE

MAIA

SIZE
 \varnothing 500 mm

BIFMA
 standard

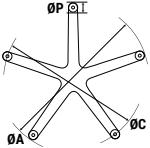

This star base features a small design and is available in polished or black aluminium. Like all our star bases, it meets the BIFMA standard, ensuring high quality and durability for professional use.

- + no nonsense design
- + small base: ideal solution for stools
- + polished or black aluminium
- + BIFMA standard

	MATERIAL	FINISH	A	C	P	H	CONE	KG
MAIA-500-AP	aluminium	polished	500	462	38	60	50	1
MAIA-500-AB	aluminium	black	500	462	38	60	50	1



ALUMINIUM BASE

GEOS



CA65-S-45-AB

ALUMINIUM BASE

GEOS

SIZE
ø 700 mm

BIFMA
standard

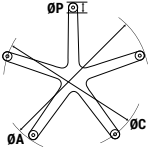

This base features bevelled edges for an industrial look and is available in polished or black finishes.

- + sturdy design
- + polished or black aluminium
- + BIFMA standard

	MATERIAL	FINISH	A	C	P	H	CONE	KG
GEOS-700-AP	aluminium	polished	700	640	45	55	50	2,3
GEOS-700-AB	aluminium	black	700	640	45	55	50	2,3



ALUMINIUM BASE

IZAR



ALUMINIUM BASE

IZAR

SIZE
 \varnothing 725 mm

BIFMA
 standard

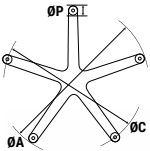

- + heavy duty base
- + polished or black aluminium
- + BIFMA standard

	MATERIAL	FINISH	A	C	P	H	CONE	KG
IZAR-725-AP	aluminium	polished	725	680	45	100	50	2,6
IZAR-725-AB	aluminium	black	725	680	45	100	50	2,6



ALUMINIUM BASE

NASH

SIZE
ø 645 mm

BIFMA
standard

- + no nonsense design
- + polished aluminium
- + BIFMA standard

	MATERIAL	FINISH	A	C	P	H	CONE	KG
NASH-645-AP	aluminium	polished	645	600	45	85	50	1,6

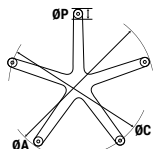

ALUMINIUM BASE

HEZE

SIZES

ø 500 mm
ø 600 mm

- + aluminium base
- + polished top,
black coated ribs

	MATERIAL	FINISH	A	C	P	H	CONE	KG
HEZE-500-AP	aluminium	polished / black	500	483	17	65	50	0,9
HEZE-600-AP	aluminium	polished / black	600	583	17	75	50	1,2

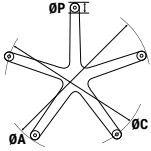

ALUMINIUM BASE

TIAKI



ALUMINIUM BASE

TIAKI

SIZE
ø 660 mm

BIFMA
standard

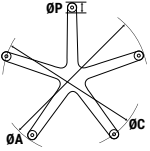

- + modern design
- + polished or black aluminium
- + BIFMA standard

	MATERIAL	FINISH	A	C	P	H	CONE	KG
TIAKI-660-AP	aluminium	polished	660	642	18	62	50	1,9
TIAKI-660-AB	aluminium	black	660	642	18	62	50	1,9



ALUMINIUM / NYLON BASE

PROPUS

BLACK
NYLON



CA65-S-18-FR-0

ALUMINIUM / NYLON BASE

PROPUS

SIZE
ø 700 mm

BIFMA
standard

AVAILABLE
IN NYLON &
ALUMINIUM

This timeless base is available in both cast aluminium and nylon, making it a versatile choice for chair collections that span different price ranges.

- + modern design
- + available in nylon and aluminium
- + BIFMA standard

	MATERIAL	FINISH	A	C	P	H	CONE	KG
PROPUS-700-AP	aluminium	polished	700	679	21	95	50	1,9
PROPUS-700-NY	nylon	black	700	679	21	95	50	1,5

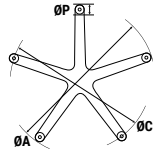

POLISHED
ALUMINIUM



ALUMINIUM / NYLON BASE

TALITHA



BLACK
NYLON



ALUMINIUM / NYLON BASE

TALITHA

SIZE

 ø 640 mm
 ø 700 mm

BIFMA
 standard

 AVAILABLE
 IN NYLON &
 ALUMINIUM

This versatile base, available in both cast aluminium and nylon, offers an excellent solution for chair collections across various price points. Its robust construction and straightforward structure make it ideal for a wide range of environments, from offices and industrial spaces to home offices.

- + modern design
- + available in 2 sizes
- + polished aluminium
- + BIFMA standard

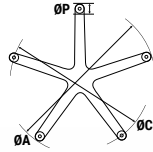

	MATERIAL	FINISH	A	C	P	H	CONE	KG
TALITHA-640-AP	aluminium	polished	640	617	23	95	50	1,7
TALITHA-700-AP	aluminium	polished	700	677	23	95	50	1,9
TALITHA-640-NY	nylon	black	640	617	23	95	50	1,3
TALITHA-700-NY	nylon	black	700	677	23	95	50	1,8



ALUMINIUM / NYLON BASE

ARIEL

BLACK
NYLON



ALUMINIUM / NYLON BASE

ARIEL

SIZE
ø 700 mm

BIFMA
standard

AVAILABLE
IN NYLON &
ALUMINIUM

This new, modern-style base is available in polished aluminium, black coated aluminium, and nylon. Its sleek design offers a contemporary look while ensuring durability and versatility for a variety of applications.

- + new modern design
- + available in nylon and aluminium
- + BIFMA standard

	MATERIAL	FINISH	A	C	P	H	CONE	KG
ARIEL-700-AP	aluminium	polished	700	680	25	80	50	1,8
ARIEL-700-AB	aluminium	black	700	680	25	80	50	1,8
ARIEL-700-NY	nylon	black	700	680	25	80	50	1,5

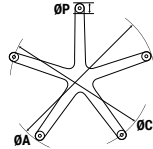

NYLON BASE

FURUD

SIZES

∅ 480 mm
∅ 560 mm

BIFMA
standard

This compact nylon base is ideal for small stools and chairs, offering stability and durability in a space-saving form.

+ black nylon
+ BIFMA standard

	MATERIAL	FINISH	A	C	P	H	CONE	KG
FURUD-480-NY	nylon	black	480	442	38	70	50	0,9
FURUD-560-NY	nylon	black	560	522	38	70	50	1,3

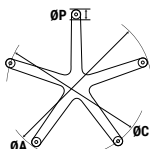

NYLON BASE

MATAR

SIZES

ø 560 mm
 ø 600 mm
 ø 640 mm
 ø 700 mm

BIFMA
standard

The MATAR has been a part of our core collection for years, and for good reason. Its solid construction and functional design make it a standout choice. Additionally, the MATAR offers excellent value for money, making it an affordable option without compromising on quality.

+ black nylon

+ BIFMA standard

	MATERIAL	FINISH	A	C	P	H	CONE	KG
MATAR-560-NY	nylon	black	560	522	38	70	50	1,2
MATAR-600-NY	nylon	black	600	562	38	70	50	1,4
MATAR-640-NY	nylon	black	640	602	38	70	50	1,6
MATAR-700-NY	nylon	black	700	662	45	70	50	2,0

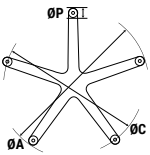



HOMAM-460-C

POLAR-610-AP

CETUS-435-B

MATAR-600-NY

CA006



FOOTRESTS

FOOTRESTS

Adjustable footrests are an excellent addition to chairs with a high seating position. They improve posture and circulation, encouraging greater movement at the desk.

This helps reduce pain, fatigue, stiffness, and discomfort caused by static muscle tension and poor circulation. An ideal solution for dynamic sit-stand workstations.

HOMAM

ORION

RIGEL

CETUS



FOOTREST

CETUS

- + clamp handle
- + black nylon spokes
- + black or chrome ring
- + BIFMA standard



This easy-to-mount footrest is a perfect match with nylon bases. It's available with a chrome or black coated ring.

	MATERIAL	FINISH	MATERIAL RING	FINISH RING	Ø	KG
CETUS-435-C	nylon	black	steel	chrome	435	1,2
CETUS-435-B	nylon	black	steel	black	435	1,2



FOOTREST

HOMAM

- + hand wheel
- + black aluminium spokes
- + chrome ring
- + BIFMA standard

BIFMA
standard

The most popular footrest is secured by rotary knob. It is available in two sizes.

	MATERIAL	FINISH	MATERIAL RING	FINISH RING	Ø	KG
HOMAM-460-C	aluminium	black	steel	chrome	460	1,5
HOMAM-510-C	aluminium	black	steel	chrome	510	1,7



FOOTREST

RIGEL

- + turn/lock principal
- + chrome ring, black spokes
- + BIFMA standard

BIFMA
standard

A footring with an invisible clamp system. Highly popular for its clean design.

	MATERIAL	FINISH	MATERIAL RING	FINISH RING	Ø	KG
FR103-C	aluminium	black	aluminium	chrome	460	1,4



FOOTREST

ORION

- + turn & clamp
- + black aluminium spokes
- + flat aluminium ring
- + BIFMA standard

BIFMA
standard

The ORION features the most advanced clamping system on the market. Simply turn the ring around the gas cylinder and secure it with the lever.

	MATERIAL	FINISH	MATERIAL RING	FINISH RING	Ø	KG
ORION-460-AP	aluminium	black	aluminium	polished	460	1,6
ORION-510-AP	aluminium	black	aluminium	polished	510	1,8

FLAT
SURFACE



DISC BASE

ALGOL



DISC BASE

ALGOL

- + modern design
- + nylon glides included

Aluminium trumpet base with a \varnothing 50 mm cone connector, suitable for turning spindles and gas cylinders.

	MATERIAL	FINISH	\varnothing	H	CONE	KG
BA633-P	aluminium	polished	460	135	50	2,0
BA633-B	aluminium	black	460	135	50	2,0



DISC BASE

MILKY WAY

This tooltray base, with a diameter of 400 mm, is made from shock-resistant plastic and features 75 mm easy-rolling rubber castors, two of which are braked. (The castors are pre-mounted on the base). Two toolboxes are included. The base has a $\varnothing 50$ cone, making it compatible with all standard gas cylinders. (A wide range of mechanisms and seats is also available.)

	DESCRIPTION	\varnothing	H	\varnothing CASTORS
BA632	Base with castors and 2 tool boxes	400	125	75
BA632-TB	Additional tool box (max. 6 per base)			



Recommended mechanisms and seats

	DESCRIPTION	FINISH	SIZE
SM001-A	steel mechanism with ring adjustment	black	$\varnothing 375$
SM015	steel mechanism with ring adjustment	black	$\varnothing 300$
PU266	polyurethane stool	black	$\varnothing 340$
PU258-B	polyurethane round seat	black	$\varnothing 365$
PU263	round seat	black	$\varnothing 355$



SM001-A



SM015



PU266



PU258



PU263

DISC BASE

TWIST

- + modern design
- + glides included



**DYNAMIC
SEATING**

This round pivoting base features a 3D movement element compatible with gas cylinders of 50 mm in diameter. This innovative chair base encourages continuous movement, keeping your muscles active and strengthening your back through constant posture adjustments.

	MATERIAL	FINISH	Ø	H	CONE
BA950-50-B	aluminium/nylon	black	400	100	50
BA950-50-P	aluminium/nylon	polished	400	100	50





CYLINDERS



**The eco-friendly choice
for the next generation**



GAS CYLINDERS

ECO CYLINDER

Lead with sustainability!

Committing to sustainable practices in your operations and production processes helps secure a better future for people, your organization, and our planet.

Chrome III Method

ACP International has initiated a shift from the Chrome VI plating process to Chrome III plating for gas cylinders. This more environmentally friendly method reduces pollution and offers a sustainable solution. **Just Ask!**



CHROME VI FREE CYLINDER

To benefit people, your organization and our planet

GAS CYLINDERS

STANDARD CHROME

CONE
28

6 YEAR
GUARANTEE

CLASS
3

CLASS
4

- + wall thickness large pipe: 1,5 mm
- + wall thickness spindle: 2,5 mm
- + force: 350 Newton

Our standard gas cylinders comply with the EN 16955:2017 standard (formerly DIN 4550). They meet at least Class 3 (certified for users up to 120 kg) or Class 4 (certified for users up to 150 kg). These gas cylinders are equipped with an 80 mm long bearing bush for optimal guidance, ensuring an axial play of no more than 0.6 mm.

FINISH CHROME COLUMNS

C chrome column, chrome spindle (class 3)

CL chrome column, light nitrated spindle (class 4)

	B	D-B	D	Y	V	C	A
CG065-100-CL	65	110	175	100	160	210	275
CGW075-155-C	75	60	135	155	170	215	290
CG075-070-CL	75	145	220	70	170	215	290
CG080-100-C	80	125	205	100	180	225	305
CG100-115-CL	100	130	230	115	195	245	345
CG100-055-CL	100	190	290	55	195	245	345
CG110-100-C	110	130	240	100	185	230	340
CG120-085-CL	120	180	300	85	215	265	385
CG125-120-CL	125	135	260	120	210	255	380
CG130-150-C	130	95	225	150	205	245	375
CG130-145-CL	130	125	255	145	225	270	400
CG130-110-CL	130	160	290	110	225	270	400
CG130-070-C	130	200	330	70	225	270	400
CG140-105-CL	140	180	320	105	235	285	425
CG140-090-CL	140	195	335	90	235	285	425
CG140-065-CL	140	220	360	65	235	285	425
CG140-055-CL	140	230	370	55	235	285	425
CGW140-065-C	140	230	370	65	230	295	435
CG160-065-CL	160	240	400	65	260	305	465
CG180-100-CL	180	235	415	100	280	335	515
CGW200-065-C	200	305	505	65	315	370	570
CG200-070-CL	200	290	490	65	300	355	555
CG260-070-CL	260	360	620	70	380	430	690
CG305-070-C	305	435	740	70	430	505	810

GAS CYLINDER WITH LOW PRESSURE (200 NEWTON)

CG130-070-C2	130	200	330	70	225	270	400
--------------	-----	-----	-----	----	-----	-----	-----

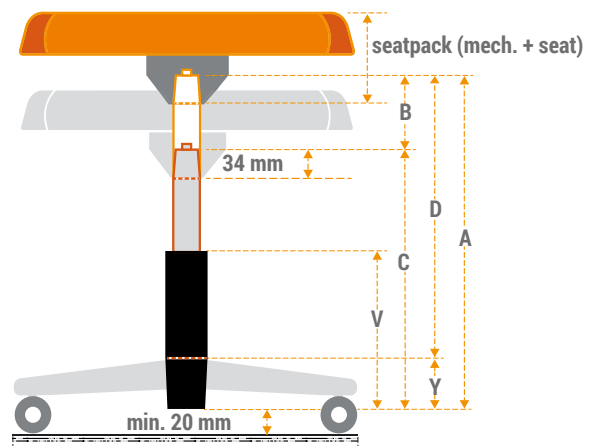

CYLINDERS

GAS CYLINDERS

STANDARD BLACK

CONE
286 YEAR
GUARANTEECLASS
3CLASS
4

- + wall thickness large pipe: 1,5 mm
- + wall thickness spindle: 2,5 mm
- + force: 350 Newton

FINISH BLACK COLUMNS

B black column, chrome spindle (class 3)**BB** black column, black nitrated spindle (class 4)

	B	D-B	D	Y	V	C	A
CG065-100-BB	65	110	175	100	160	210	275
CG075-070-BB	75	145	220	70	170	215	290
CG080-100-B	80	125	205	100	180	225	305
CG100-115-BB	100	130	230	115	195	245	345
CG100-055-BB	100	190	290	55	195	245	345
CG110-100-B	110	130	240	100	185	230	340
CG120-085-BB	120	180	300	85	215	265	385
CG120-120-BB	120	145	265	120	215	265	385
CG125-120-BB	125	135	260	120	210	255	380
CG130-150-B	130	95	225	150	205	245	375
CG130-145-BB	130	125	255	145	225	270	400
CG130-110-BB	130	160	290	110	225	270	400
CG140-130-BB	140	130	270	130	215	260	400
CG140-105-BB	140	180	320	105	235	285	425
CG140-090-BB	140	195	335	90	235	285	425
CG140-055-BB	140	230	370	55	235	285	425
CG140-065-BB	140	220	360	65	235	285	425
CGW140-065-B	140	230	370	65	230	295	435
CG160-065-BB	160	240	400	65	260	305	465
CG180-100-BB	180	235	415	100	280	335	515
CG200-070-BB	200	285	485	70	300	355	555
CG260-070-BB	260	360	620	70	380	430	690
CG260-055-B	260	375	635	55	380	430	690
CG305-070-B	305	435	740	70	430	505	810

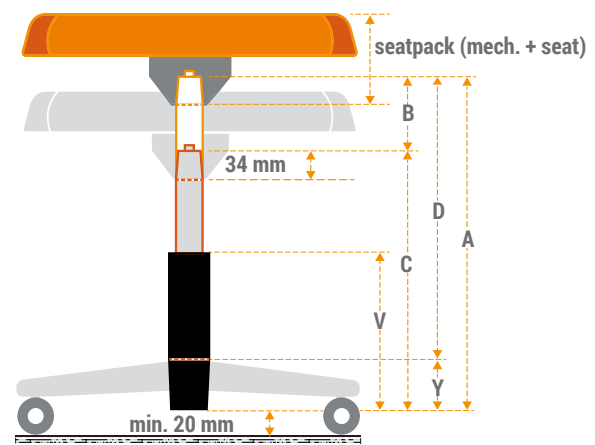

GAS CYLINDERS

DUAL CONTROLLED

DIRECT
FROM
STOCK6 YEAR
GUARANTEEFOOT
& HAND
CONTROL

- + wall thickness large pipe: 1,5 mm
- + wall thickness spindle: 2,5 mm
- + force: 300 Newton

For specific applications, we offer gas cylinders that can be operated from both the bottom and the top. At the bottom, the gas cylinder is controlled by a foot-operated ring. This ring is available in stainless steel (with a wheel recess) and in a chrome-plated version, making it ideal for medical furniture.

FINISH: CC chrome column, chrome spindle

B	A	C	V	Y	D=A-Y	F	CHROME/CHROME	CHROME/INOX
140	440	300	230	85	355	300	CG540	CG501
200	570	370	315	70	485	300	CG541	CG502
265	700	435	370	70	615	300	CG542	CG503

Related products



CG827
ø325 mm stainless steel



CG836
ø300 mm steel chrome

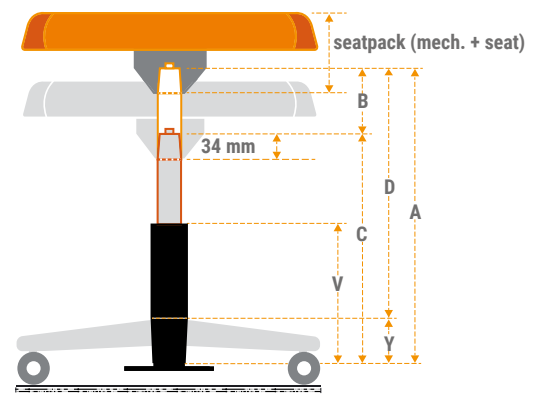

GAS CYLINDERS

FOOT CONTROLLED**+ complete foot operated
disc base with gas cylinder**

This inhouse developed base includes a foot operated gas cylinder. The stainless steel control is positioned above the base. The integrated footring provides a stable support for the feet in a high seating position and secures a controlled height adjustment while seated.

DESCRIPTION

IXION-600-DISC	consisting parts:	
	castors	65 mm
	base	600 mm
	gas cylinder	stroke 200 mm
	footrest	510 mm



GAS CYLINDERS

NON ROTATING

DIRECT
FROM
STOCK6 YEAR
GUARANTEECLASS
3

- + wall thickness large pipe: 1,5 mm
- + wall thickness spindle: 2,5 mm
- + force: 320 Newton

Non-rotatable gas cylinder with height adjustment. The spindle is fixed with a profile so that it can not rotate. Equipped with a smoothly working height adjustment. Available with a \varnothing 50 mm large pipe.

FINISH: CC chrome column, chrome spindle
BC black column, chrome spindle

B	A	C	V	Y	D=A-Y	F	CHROME	BLACK
140	425	285	235	65	360	320	CGN140-065-CC	CGN140-065-BC
200	555	355	300	65	490	320	CGN200-065-CC	CGN200-065-BC
260	690	430	380	65	625	320	CGN260-065-CC	CGN260-065-BC

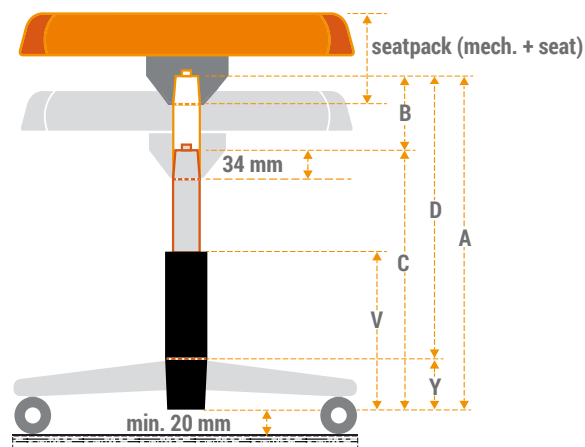

CYLINDERS

HEIGHT ADJUSTABLE COLUMN

HYDRAULIC FOOT PUMP

**DIRECT
FROM
STOCK**

**6 YEAR
GUARANTEE**

- + \varnothing 87 mm
- + stroke 170 mm
- + retracted length 270 mm
- + dynamic pushing force: 300 kg
- + maximum static load: 400 kg

Hydraulic foot pump with chrome finish and a \varnothing 50 mm cone mounting. The height of the pump can be adjusted using the foot pedal, and rotation can be locked by pressing the foot pedal upwards. The hydraulic foot pump is compatible with most bases but is best suited for the Ixion and Polar bases.

For a perfect fit, a special cover ring is available for the Polar base. The seat plate SM813 is most suitable when using the foot pump to add a seat top.

DESCRIPTION

CG813-170-B hydraulic pump

Recommended bases

POLAR BASES

IXION BASES

Related products

SM813 seat plate with hole pattern 100 x 100 and 3° angle

PU813 cover ring for POLAR base



SM813

PU813

POLAR

GAS CYLINDERS

SPECIALS

In addition to the standard range of gas cylinders, we offer a variety of specialized solutions to meet special requirements. These include:

- + **conductive gas cylinders**
- + **gas cylinders with a cable release**
- + **gas cylinders with wiper**
- + **gas cylinders in different colours**
- + **super heavy duty gas cylinders**
- + **auto-return and/or auto-height**
- + **lower or higher forces than standard**

Would you like to explore more? **Just Ask!**



HEIGHT ADJUSTABLE COLUMN

TABLE COLUMN

This height-adjustable column operates via a lever and Bowden cable, offering smooth and precise adjustments. Its flat base is designed for easy mounting on a floor plate. Alternatively, with a cone adapter (ø 50 mm), the column can be installed in a (chair) base. A mobile stand is also available for added versatility. This column is ideal for supporting table tops up to 800 x 800 mm, making it suitable for a range of applications.

	MATERIAL	FINISH	Ø	FORCE	RANGE		MATERIAL	FINISH	Ø	FORCE	RANGE
LC600-B-100	aluminium/steel	black	70/75	100N	600-1000	LC700-B-120	aluminium/steel	black	70/75	100N	700-1100
LC600-W-100	aluminium/steel	white	70/75	100N	600-1000	LC700-W-120	aluminium/steel	white	70/75	100N	700-1100
LC600-G-100	aluminium/steel	grey	70/75	100N	600-1000	LC700-G-120	aluminium/steel	grey	70/75	100N	700-1100



GAS CYLINDERS

COVERS

These durable dust covers offer excellent protection against grease and effectively keep the cylinder clean and free from dust, ensuring reliable performance and longevity.

	MATERIAL	SIZE L
PP002	polypropylene	180
PP005	polypropylene	320
COVER-182-1	polypropylene	182
COVER-245-1	polypropylene	245
COVER-293-1	polypropylene	293
PP008	polypropylene	270
PP024	polypropylene	330



PP002



PP005



PP008



PP024



COVER-182-1



COVER-245-1



COVER-293-1



GAS CYLINDERS

WELDING CONES

These welding cones are intended for use at the top or bottom of a gas cylinder. They can also be used to create custom seat plates.



	AS200	AS202
INNER CONE Ø	28	50
HEIGHT	40	50



Ideal for furniture construction, these welding cones are suitable for the top of a turning spindle. They can also be used to fabricate custom frames.



	AS214	AS215	AS208
INNER CONE Ø	28	28	30
HEIGHT	85	49	45



To construct a custom metal base, we offer a welding cone paired with an auto-return spindle (TSA54-50-B).

	HEIGHT	OUTER Ø BOTTOM	OUTER Ø TOP	INNER CONE
AS201	75	60	62	54

	A	V	CONE
TSA54-50-B	115	65	28



AS201

TSA54-50-B



CASTORS

LET'S PUT THINGS INTO MOTION

Explore our collection of top-selling castors, featuring elegant Italian design – the perfect FINISH touch for any office chair. Each standard castor comes equipped with a silent pin and is backed by a 5-year guarantee. Need help choosing? **Just Ask!**

**DIRECT
FROM
STOCK**

**5 YEAR
GUARANTEE**



ø50 | adapter ø18



ø50 | adapter ø18



ø50 | adapter ø18



ø50 | adapter ø18



ø50 | adapter ø23



ø50 | adapter ø38



ø50 | adapter ø38



ø50 | adapter ø38



ø50 | adapter ø38



ø50 | adapter ø38 with ESD



ø65 | adapter ø18



ø65 | adapter ø18



ø65 | adapter ø18



ø65 | adapter ø24



ø65 | adapter ø23



ø65 | adapter ø23



ø65 | adapter ø38



ø65 | adapter ø38



ø65 | adapter ø45



ø50 | adapter ø45



ø75 | adapter ø45



ø75 | adapter ø45



ø75 | adapter ø45



POLAR-S-530-AP

CA65-S-23-AB



PROPUS-700-AP

CA65-S-18-FR-0



IXION-660-AB

CA65-S-38-AB



MATAR-600-NY

CA50-S-38-AB



ANTAR5-700-AP

CA65-H-18-FR-C

CASTORS

LET'S PUT THINGS INTO MOTION

HARD OR SOFT TREAD?

In the past, castors with soft treads were used on hard floors, while those with hard treads were suited for soft floors. Today, 90% of all castors feature a soft tread, ensuring excellent performance on both hard and soft surfaces.

LEGEND

FR	free running	no resistance
AB	brake unloaded	castors brake when no one is seated
LB	brake loaded	castors brake when someone is seated

**DIRECT
FROM
STOCK**

**SILENT
PIN**

SILENT PIN

Most of our castors are equipped with a 'silent' pin which guarantees a silent operation.

CASTORS

Ø50



ADAPTER	DESCRIPTION				
---------	-------------	--	--	--	--

universal

CA50-S-00-AB	soft tread, brake unloaded	50	60	11x22	35
CA50-S-00-FR	soft tread, free running	50	60	11x22	35



Ø18

CA50-H-18-AB	hard tread, brake unloaded	50	18	60	11x22	35
CA50-H-18-FR	hard tread, free running	50	18	60	11x22	35
CA50-H-18-LB	hard tread, brake loaded	50	18	60	11x22	35



CA50-S-18-AB	soft tread, brake unloaded	50	18	60	11x22	35
CA50-S-18-FR	soft tread, free running	50	18	60	11x22	35



CA50-S-18-AB-C	soft tread, brake unloaded, chrome cap	50	18	60	11x22	35
----------------	--	----	----	----	-------	----



Ø23

CA50-S-23-AB	soft tread, brake unloaded	50	23	60	11x22	35
--------------	----------------------------	----	----	----	-------	----



Ø38

CA50-H-38-AB	hard tread, brake unloaded	50	38	60	11x22	35
CA50-H-38-FR	hard tread, free running	50	38	60	11x22	35



CA50-S-38-AB	soft tread, brake unloaded	50	38	60	11x22	35
CA50-S-38-FR	soft tread, free running	50	38	60	11x22	35
CA50-S-38-LB	soft tread, brake loaded	50	38	60	11x22	35



CA50-S-38-AB-C	soft tread, brake unloaded, chrome cap	50	38	60	11x22	35
----------------	--	----	----	----	-------	----



CA50-S-38-AB-A	soft tread, brake unloaded, conductive	50	38	60	11x22	35
CA50-S-38-LB-A	soft tread, brake loaded, conductive	50	38	60	11x22	35

LET'S PUT THINGS INTO MOTION

CASTORS

Ø65



HARD OR SOFT TREAD?

In the past, castors with soft treads were used on hard floors, while those with hard treads were suited for soft floors. Today, 90% of all castors feature a soft tread, ensuring excellent performance on both hard and soft surfaces.

LEGEND

FR	free running	no resistance
AB	brake unloaded	castors brake when no one is seated
LB	brake loaded	castors brake when someone is seated

**DIRECT
FROM
STOCK**

**SILENT
PIN**

SILENT PIN

Most of our castors are equipped with a 'silent' pin which guarantees a silent operation.

ADAPTER	DESCRIPTION					
Ø18						
CA65-S-18-AB	soft tread, brake unloaded	65	18	70	11x22	35
CA65-S-18-FR	soft tread, free running	65	18	70	11x22	35
CA65-H-18-AB-C	hard tread, brake unloaded, chrome house and cap	65	18	70	11x22	35
CA65-H-18-FR-C	hard tread, free running, chrome house and cap	65	18	70	11x22	35
CA65-S-18-AB-C	soft tread, brake unloaded, chrome house and cap	65	18	70	11x22	35
CA65-S-18-FR-C	soft tread, free running, chrome house and cap	65	18	70	11x22	35
CA65-S-18-AB-D	soft tread, brake unloaded, chrome house, black cap	65	18	70	11x22	35
CA65-S-18-FR-O	soft tread, open house adjustable rolling resistance	65	18	70	11x22	35
Ø23						
CA65-H-23-AB	hard tread, brake unloaded	65	23	70	11x22	35
Ø23						
CA65-S-23-AB	soft tread, brake unloaded	65	23	70	11x22	35
Ø24						
CA65-S-24-FROW	soft tread, free running, open house, white adjustable rolling resistance	65	24	70	11x22	35

CASTORS

Ø65



ADAPTER	DESCRIPTION					
Ø28						
CA65-S-28-AB	soft tread, brake unloaded	65	28	70	11x22	35
CA65-S-28-FR	soft tread, free running	65	28	70	11x22	35



Ø38						
CA65-H-38-AB	hard tread, brake unloaded	65	38	70	11x22	35



Ø38						
CA65-S-38-AB	soft tread, brake unloaded	65	38	70	11x22	35
CA65-S-38-FR	soft tread, free running	65	38	70	11x22	35



Ø42						
CA65-S-42-FR	soft tread, free running	65	42	70	11x22	35



Ø45						
CA65-S-45-AB	soft tread, brake unloaded	65	45	70	11x22	35

SKATE CASTORS

SKATE



ADAPTER	DESCRIPTION					
Ø45						
CA704	transparent PU, zinc plated housing	75	45	100	11x22	50



CA703	transparent PU, black nylon housing	75	45	100	11x22	50
-------	-------------------------------------	----	----	-----	-------	----

INDUSTRIAL WHEELS

IW



ADAPTER	DESCRIPTION					
Ø38						
IW200	rubber-wheel with flange ball bearing	50	38	72	11x22	50
IW201	rubber-wheel with flange ball bearing	75	38	101	11x22	50

GLIDES



CA55-56-G



CA006



CA006-F



CA009



CA48-33-N



CA52-33-G



CA40-13-G



CA022



CA24-06-N



CA24-05-F



CA30-10-G

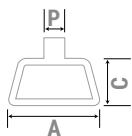

	MATERIAL	A	C	P
CA006	nylon	50	55	11x22
CA006-F	nylon/felt	46	54	11x22
CA009	nylon	52	33	11x22
CA40-13-G	nylon	40	13	11x22
CA48-33-N	nylon	48	33	11x22
CA52-33-G	nylon	52	33	11x22
CA55-56-G	nylon	55	56	11x22

	MATERIAL	A	C	P
CA022	nylon	40	7	11x15
CA24-06-N	nylon	24	6	11x22
CA24-05-F	nylon/felt	24	6	11x22
CA30-10-G	nylon	30	10	11x10

GLIDES WITH INSERTS

SMART GLIDE

The Smart Glide is the first simple, protective glide-and-lock system featuring replaceable inserts that can be swapped out effortlessly. This innovative system combines simplicity with practicality, offering long-term protection for both furniture and floors.

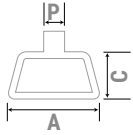

	MATERIAL	A	C	P
CA16-03	nylon base part	16	3	11
CA16-03-N	nylon insert	16	3	
CA16-03-F	felt insert	16	3	
CA20-03	nylon base part	20	3	11
CA16-03-N	nylon insert	16	3	
CA16-03-F	felt insert	16	3	
CA22-03	nylon base part	22	3	11
CA22-03-N	nylon insert	22	3	
CA22-03-F	felt insert	22	3	

	MATERIAL	A	C	P
CA25-03	nylon base part	25	3	11
CA25-03-N	nylon insert	25	3	
CA25-03-F	felt insert	25	3	



NYLON INSERT



FELT INSERT



CA16-03



CA20-03



CA22-03



CA25-03



CA16-03-F



CA16-03-N



CA22-03-F



CA25-03-F



CA16-03-N



CA16-03-N



CA22-03-N



CA25-03-N

RING MECHANISMS

SM001-A

Steel mechanism
with ring adjustment



These steel ring mechanisms are commonly used for stool seats, providing stable support and long-lasting performance.

	MATERIAL	FINISH	Ø	CONE	HEIGHT	HOLE PATTERN
SM001-A	steel	black	250	28	55	115 x 115 - 135 x 135

**SM015**

Steel mechanism
with ring adjustment

EXTRA
LARGE
RING



	MATERIAL	FINISH	Ø	CONE	HEIGHT	HOLE PATTERN
SM015	steel	black	300	28	55	115 x 115 - 135 x 135



RING MECHANISMS

SM004-A**Steel mechanism
with ring adjustment**

	MATERIAL	FINISH	Ø	CONE	HEIGHT	HOLE PATTERN
SM004-A	steel	black	250	28	60	125 x 125 - 145 x 145

**LARGE
HOLE
PATTERN**
MAX 145 X 145

RING MECHANISMS

SM002

**Aluminium mechanism
with ring adjustment**



This aluminium ring mechanism is the perfect solution for stool seats, adding both durability and a stylish touch of elegance.

	MATERIAL	FINISH	Ø	CONE	HEIGHT	HOLE PATTERN
SM002-BB	aluminium	black	250	28	60	55 x 55 - 130 x 130
SM002-PC	aluminium	polished	250	28	60	55 x 55 - 130 x 130



RING MECHANISMS

SM005

Aluminium seat mechanism with fixed seating angle



Aluminium seat mechanism with fixed seating angle. This is the basic part of the Flexline series that can be supplemented with a rubber part (SM005-RUB) that makes dynamic sitting possible. Modern and clean appearance, suitable for medical use.

	DESCRIPTION	MATERIAL	FINISH	Ø	CONE	HEIGHT	HOLE PATTERN
SM005-PC	with ring adjustment	aluminium	polished	250	28	60	55 x 55
SM005-BB	with ring adjustment	aluminium	black	250	28	60	55 x 55
SM920-P	without ring adjustment	aluminium	polished	98	28	60	55 x 55
SM920-B	without ring adjustment	aluminium	black	98	28	60	55 x 55



MECHANISM

SM804



MECHANISM

SM804**Compact aluminium seat mechanism**

This compact aluminium seat mechanism features either a straight or bent adjustment lever, with the bent lever commonly used in combination with saddle seats. Optional components include a 3° wedge for seat tilting and a rubber insert to minimize noise generated by the release system.

	MATERIAL	FINISH	CONE	HEIGHT	HOLE PATTERN
SM804P	aluminium	polished	28	55	55 x 55
SM804B	aluminium	black	28	55	55 x 55
SM804S	aluminium	uncoated	28	55	55 x 55



SM804P



SM804B



SM804S

Adjustment levers

	DESCRIPTION	FINISH	LENGTH
AS405-170	lever straight	zinc	170
AS405-170-B	lever straight	black	170
AS405-190	lever straight	zinc	190
AS405-190-B	lever straight	black	190
AS405-210	lever straight	zinc	210
AS405-210-B	lever straight	black	210
AS405-170-22	lever bended	zinc	170
AS503-A	lever knob	black nylon	



AS405-170-B



AS405-190



AS405-210-B



AS405-170-22



AS503-A

Optional

PP907	wedge for 3° tilting
AS507	rubber insert



AS507



PP907



MECHANISM

SM803

Steel mechanism with or without adjustment lever

These plates make it easy to connect a spindle or gas cylinder to a seat.
An optional lever can be added to enable height adjustments of the gas cylinder.

	MATERIAL	FINISH	CONE	HEIGHT	HOLE PATTERN
SM803	steel	black	28	55	150 x 150 -160 x 160

**Optional adjustment lever**

AS502	handle
AS400	lever
AS902	mounting spring



MECHANISMS

SM825

Steel mechanism

	MATERIAL	FINISH	CONE	HEIGHT	HOLE PATTERN
SM825	steel	black	28	60	130 x 130 - 150 x 150

**SM826**Steel mechanism
with adjustment lever

	MATERIAL	FINISH	CONE	HEIGHT	HOLE PATTERN
SM826	steel	black	28	60	130 x 130 - 150 x 150



MECHANISM

SM821

Steel mechanism with
adjustment lever and
adapter for a flat back bar

	MATERIAL	FINISH	CONE	HEIGHT	HOLE PATTERN
SM821	steel	black	28	60	130 x 130 - 150 x 150

**Back bar**

	DESCRIPTION	FINISH	LENGTH
AS641	back bar flat, 45 mm	chrome	340
AS939	bracket	chrome	104



MECHANISM

SM824

Steel mechanism with adjustment lever and adapter for a flat or open back bar

	MATERIAL	FINISH	CONE	HEIGHT	HOLE PATTERN	SEAT ANGLE
SM824	steel	black	28	60	170 x 200	3°

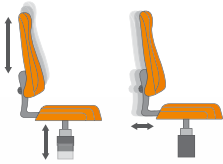

Back bars

	DESCRIPTION	FINISH	LENGTH
AS640	open back bar, shaft Ø 10 mm	chrome	340
AS938	bracket	chrome	104
AS641	back bar, flat 45 mm	chrome	340
AS939	bracket	chrome	104



MECHANISM

SM514

Steel mechanism with seat angle, adjustable back angle and adapter for flat back bar (not included)



The SM514 and SM515 are equipped with unbreakable, flexible levers, providing reliable performance and long-lasting use.

	MATERIAL	FINISH	CONE	HEIGHT	HOLE PATTERN	SEAT ANGLE	BACK ANGLE
SM514	steel	black	28	70	220/96 x 150	fixed 3°	24°



Matching back bars

	DESCRIPTION	FINISH	LENGTH
AS650-B	flat, metal back bar with rod (95 mm)	black	400
AS650-C	flat, metal back bar with rod (95 mm)	chrome	400
AS653-B	flat, metal back bar, extra long, with rod (95 mm)	black	452
AS653-C	flat, metal back bar, extra long, with rod (95 mm)	chrome	452
AS655-B	flat, metal back bar with plate	black	460
AS655-C	flat, metal back bar with plate	chrome	460



AS650-B AS650-C AS653-B AS653-C AS655-B AS655-C

MECHANISM

SM305-A

**Steel mechanism
with tilt adjustment**



Suitable for saddle seats and sit-stand seats.

	MATERIAL	FINISH	CONE	HEIGHT	HOLE PATTERN	SEAT ANGLE
SM305-A	steel	black	28	65	90/100 x 100	15°



MECHANISM

SM510

Steel mechanism with independent back- and seat tilt adjustment, and adapter for oval back bar



	MATERIAL	FINISH	CONE	HEIGHT	HOLE PATTERN	SEAT ANGLE	BACK ANGLE
SM510	steel	black	28	70	170 x 200	-3° - 10°	80° - 106°

**Matching back bars**

	DESCRIPTION	FINISH	LENGTH
AS530	back bar with rod	black	425
AS540	back bar with plate	black	425



AS530

AS540

MECHANISM

SM515

Steel mechanism with independent back- and seat angle adjustment, and adapter for flat back bar (not included)

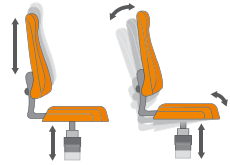

For work chairs and task chairs, these mechanisms are the ideal choice if reliability and ease of use are of paramount importance.

	MATERIAL	FINISH	CONE	HEIGHT	HOLE PATTERN	SEAT ANGLE	BACK ANGLE
SM515	steel	black	28	70	220/96 x 150	adjustable 14°	24°



Matching back bars

	DESCRIPTION	FINISH	LENGTH
AS650-B	flat, metal back bar with rod (95 mm)	black	400
AS650-C	flat, metal back bar with rod (95 mm)	chrome	400
AS653-B	flat, metal back bar, extra long, with rod (95 mm)	black	452
AS653-C	flat, metal back bar, extra long, with rod (95 mm)	chrome	452
AS655-B	flat, metal back bar with plate	black	460
AS655-C	flat, metal back bar with plate	chrome	460



MECHANISM

SM517

Steel mechanism with independent back- and seat angle adjustment, with adapter for flat back bar

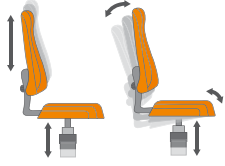

Mainly used for saddle seats with back rest. Our robust flat back bar enhances the look of each chair, providing added stability and aesthetic appeal.

	MATERIAL	FINISH	CONE	HEIGHT	HOLE PATTERN	SEAT ANGLE	BACK ANGLE
SM517	steel	black	28	65	96/100 x 100	adjustable 12°	24°



Recommended back bars

	DESCRIPTION	FINISH	LENGTH
AS653-B	flat, metal back bar, extra long, with rod (95 mm)	black	452
AS653-C	flat, metal back bar, extra long, with rod (95 mm)	chrome	452



AS653-B AS653-C

ACCESSORIES

BACK BARS

	DESCRIPTION	FINISH	LENGTH	HOLE PATTERN
AS530	oval metal back bar with rod (95 mm)	black	425	
AS540	oval metal back bar with plate	black	425	100 x 30
AS650-B	flat metal back bar with rod (95 mm)	black	400	
AS650-C	flat metal back bar with rod (95 mm)	chrome	400	
AS653-B	flat metal back bar, extra long, with rod (95 mm)	black	452	
AS653-C	flat metal back bar, extra long, with rod (95 mm)	chrome	452	
AS655-B	flat metal back bar with plate	black	460	100 x 30
AS655-C	flat metal back bar with plate	chrome	460	100 x 30
AS930-1	universal nylon back bar cover	black		85-105
AS930-A	universal nylon back bar cover, anti-static	black		85-105
PP830	nylon security pin for flat back bar	black		



The AS930-1 back bar cover is suitable for hole pattern 85 to 105 mm



MECHANISMS

SM107 - SM109

**Tilt mechanism with
tension adjustment
and locking position(s)**



Suitable for large seatshells. With tilting function.

	MATERIAL	FINISH	CONE	HEIGHT	HOLE PATTERN	SEAT ANGLE	LOCKING POSITIONS
SM107	steel	black	28	76	155 x 200	0°- 16°	1
SM109	steel	black	28	76	155 x 200	0°- 16°	5



MECHANISM

SM304

**Tilt mechanism with
tension adjustment
and locking positions**



Suitable for large seatshells. With tilting function.

	MATERIAL	FINISH	CONE	HEIGHT	HOLE PATTERN	SEAT ANGLE	LOCKING POSITIONS
SM304	steel	black	28	139	200 x 200	3°- 16°	6



6
locking
positions



MECHANISM

SM008

Steel mechanism with rubber part for dynamic seating

For dynamic seating solutions, we have included this mechanism in our product range.



	MATERIAL	FINISH	CONE	HEIGHT	HOLE PATTERN	SEAT ANGLE
SM008	steel	black	28	80	90/120 x 100	dynamic



MECHANISM

SM009

Steel mechanism for
dynamic seating.

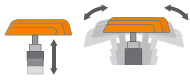

A spring-loaded rocker function allows for inclinations of up to 12° in all directions.

	MATERIAL	FINISH	CONE	HEIGHT	HOLE PATTERN	SEAT ANGLE
SM009	steel	black	28	75	120 x 120 - 130 x 130	dynamic



MECHANISM

SM130

Synchro mechanism with backrest return prevention safety function and locking positions



The seat angle can be adjusted from 0° to 7.5°, and the back angle can be adjusted from 90° to 109°.

	MATERIAL	FINISH	CONE	HEIGHT	HOLE PATTERN	SEAT ANGLE	LOCKING POSITIONS
SM130	aluminium/steel	black	28	85	155 x 200	synchro	4

4
locking
positions

**Matching back bar**

	FINISH
AS636 steel back bar, bended 90°	black



MECHANISM

SM131

Synchro mechanism with backrest return prevention safety function, locking positions and seat slider

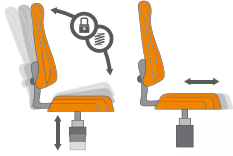

The SM130 and SM131 are the best choices if you are looking for a synchronized mechanism with a clean design. The tension adjustment knob is easily accessible, as it is located on the side. The SM131 includes an integrated seat slider function with a range of 58 mm.

	MATERIAL	FINISH	CONE	HEIGHT	HOLE PATTERN	SEAT ANGLE	LOCKING POSITIONS
SM131	aluminium/steel	black	28	105	155 x 200	synchro	4



WITH SEAT SLIDER

4
locking positions

**Matching back bar**

	FINISH
AS636 steel back bar, bended 90°	black



MECHANISM

SM112

**Mechanism with
synchron movement for
the back- and seat angle**



The SM112 is a weight-activated synchronized mechanism with four locking positions. The counterpressure is automatically adjusted to the user's weight. The SM112 can be mounted on a seat in combination with a bolt-on seat slider plate (PP847).

	MATERIAL	FINISH	CONE	HEIGHT	HOLE PATTERN	SEAT ANGLE	LOCKING POSITIONS
SM112	aluminium/steel	black	28	93	155 x 200	synchro	5

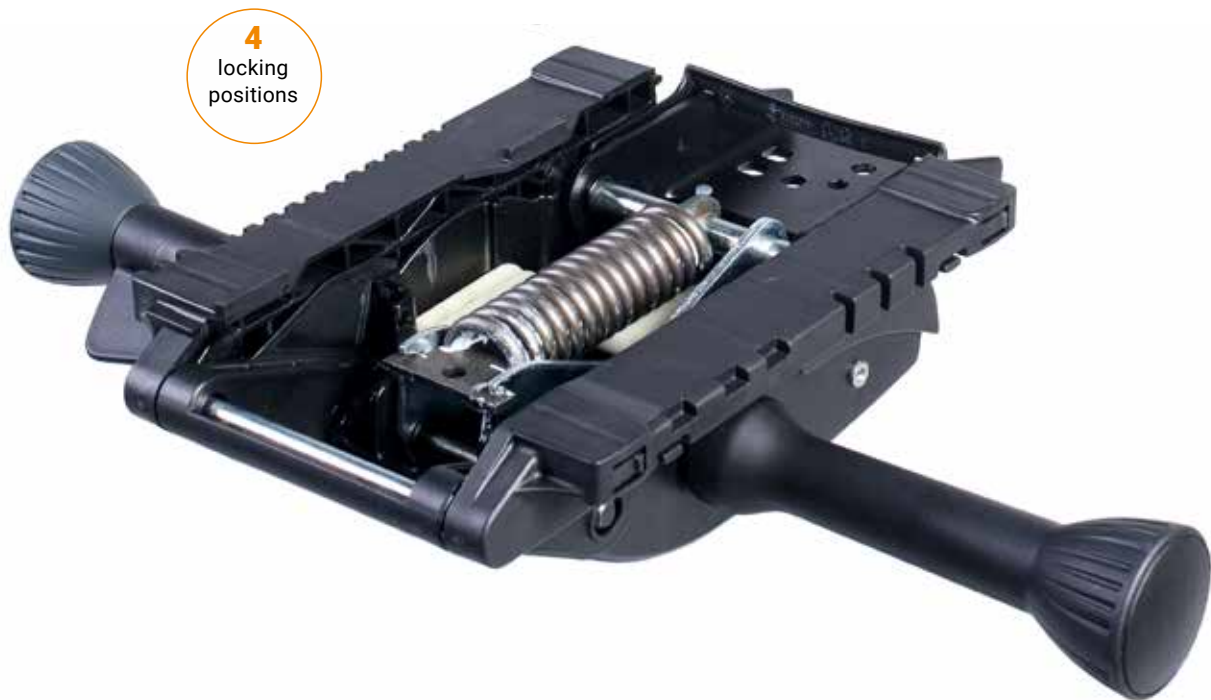
**Matching back bar**

	FINISH
AS636 steel back bar, bended 90°	black

**Matching seat slider**

	FINISH
PP847 seat slider	black



MECHANISM

SM310

Synchro mechanism with backrest return prevention, safety function and locking positions



This synchronized mechanism includes an additional feature for fine-tuning the back angle.

	MATERIAL	FINISH	CONE	HEIGHT	HOLE PATTERN	SEAT ANGLE	LOCKING POSITIONS
SM310	aluminium/steel	black	28	125	155 x 200	synchro	5

**Matching back bar**

	FINISH
AS636 steel back bar, bended 90°	black





FLEXLINE

SEAT MECHANISM

SM005

The SM005 is the base part of the Flexline series. This aluminium seat mechanism is for height adjustment by operating the ring. Add the Flex disk (SM005-RUB) for dynamic seating.



FLEXDISK

SM005-RU-B

If dynamic seating is needed, simply add the matching rubber Flexdisk. Only suitable for seats without a back rest such as stools and saddle seats.



FIXED BACK BAR

AS645

Chrome-plated back bar with a fixed height and angle. It does not affect the adjustment range of the gas spring.



FLEXLINE



**FLEX
LINE**

The Flexline program features various interchangeable chair components with a sleek look, making it ideal for medical environments.

360° SWIVEL BACK BAR

AS646

Height-adjustable, 360° swivel back bar with a low installation height. This part does not affect the gas lift's adjustment range, and the back rest can be easily adjusted using the control lever.



PU ARM / BACK REST

PU433 AND PU434

Curved polyurethane arm/back support for combined arm and back rest use. Compatible with the 360° swivel back bar (AS646).



PU BACK REST

PU431 AND PU438

Curved back rest, designed for use with the fixed back bar (AS645).



FLEXLINE MECHANISM

- + clean design
- + fixed seat angle
- + height adjustment

**FLEX
LINE**



Seat mechanism SM005

The SM005 is the central part of the Flexline series that can be expanded with other parts. This aluminium seat mechanism allows height adjustment by operating the ring. Add the Flex disk (SM005-RUB) for dynamic seating.

	DESCRIPTION	MATERIAL	FINISH	Ø	CONE	HEIGHT	HOLE PATTERN
SM005-PC	with ring adjustment	aluminium	polished	250	28	60	55 x 55
SM005-BB	with ring adjustment	aluminium	black	250	28	60	55 x 55
SM920-P	without ring adjustment	aluminium	polished	250	28	60	55 x 55
SM920-B	without ring adjustment	aluminium	black	250	28	60	55 x 55



FLEXLINE FLEXPDISK



Rubber Flexdisk

If dynamic seating is needed, simply add the matching rubber Flexdisk.

Only suitable for seats without a back rest such as stools and saddle seats.

	DESCRIPTION	MATERIAL	FINISH	HEIGHT	SEAT ANGLE
SM005-RUB-B	vulcanised rubber flexdisk	steel/rubber	black	25	variable 0° - 7° all around



Matching adapter plates

	DESCRIPTION	FINISH	HOLE PATTERN
ME871	adapter plate for saddle seats	black	100 x 100
ME872	adapter plate for stools	black	130 x 130 - 140 x 140



ME872 for stool seats



ME871 for saddle seats



FLEXLINE SWIVEL BACK BAR

- + rotatable 360°
- + height adjustment



360° Swivel back bar

Height-adjustable swivel back bar (360°) with a low installation height. This part does not affect the adjustment range of the gas lift. The back rest can be easily mounted and adjusted using the control knob, and it can also serve as a torso support.

	DESCRIPTION	FINISH	HEIGHT ADJUSTMENT	HOLE PATTERN
AS646	swiveling back bar, steel / nylon with mounting plate	black	8 positions, 70 mm	130 x 130 - 140 x 140
FINISH				
PU434	curved back rest for upholstery, molded foam			
PU433-B	polyurethane back rest	black		



FLEXLINE BACK BAR

+ fixed backbar



Fixed back bar

Chrome plated back bar with a fixed height and fixed angle. Does not affect the adjustment range of the cylinder.

	DESCRIPTION	FINISH	HOLE PATTERN
AS645	fixed back bar, steel	chrome plated	back: 90 - 92, seat: 55 x 55
		FINISH	HOLE PATTERN
PU432-B	polyurethane back rest	black	100 x 100
PU432-G	polyurethane back rest	grey	100 x 100
PU438	back rest for upholstery, molded foam		92



PU438

PU432-B

AS645

SM005-BB

SM005-PC

FLEXLINE SET



Combined set

360° Swivel back bar & PU arm / back rest.

DESCRIPTION

AR011 complete set: swivel arm incl. polyurethane part (excl. ring mechanism)

DESCRIPTION

FINISH

DESCRIPTION	FINISH
SM005 seat mechanism with ring adjustment	black or polished
AS646 360° swiveling back bar with mounting plate	black
PU433-B matching polyurethane back rest	black



Applicable seats

DESCRIPTION	FINISH	SIZE	DESCRIPTION	FINISH	SIZE
PU255-B polyurethane stool	black	ø 375	PU258-B polyurethane round seat	black	ø 365
PU256-B polyurethane stool	black	ø 375	PU259-B polyurethane stool	black	ø 380



PU255-B



PU256-B



PU258-B



PU259-B

FLEXLINE SET



Combined set

360° Swivel back bar & PU arm / back rest.

DESCRIPTION

AR012 complete set: swivel arm incl. polyurethane part (excl. ring mechanism)

DESCRIPTION

FINISH

DESCRIPTION	FINISH
SM005 seat mechanism with ring adjustment	black or polished
AS646 360° swiveling back bar with mounting plate	black
PU434 matching polyurethane back rest	black



Applicable molded foam parts

	DESCRIPTION	Ø / WIDTH	HEIGHT
PU257	round seat for upholstery	400	70
PU294	round seat with recessed legs for upholstery	400	70
PU296	ergonomic shaped saddle for upholstery	420	80



PU296



PU257



PU294

ARMRESTS

AR111

- + height adjustable
- + rotatable

Pair of 3D armrests, easy to adjust, with a rotatable top part for pads.

	DESCRIPTION	MATERIAL	FINISH	HEIGHT ADJUSTMENT	WIDTH	ROTATION
AR111	pair of armrests	nylon/steel	black	8 positions, 80 mm	n.a.	30°

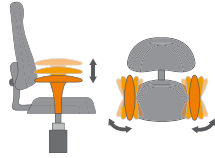
**Applicable part**

	DESCRIPTION	FINISH
PU082	arm pad	polyurethane
AR904	arm bracket	black



PU082



AR904

ARMRESTS

AR111-SET-S

- + complete set
- + rotatable arm pads
- + height adjustment

Set of 3D armrests, including pads and a bracket specifically made for mounting on a saddle seat. The armrests are easily adjustable to the desired height, and the pads are rotatable. Compatible only with the SM517 mechanism.

	DESCRIPTION	MATERIAL	FINISH	HEIGHT ADJUSTMENT	WIDTH	ROTATION
AR111-SET-S	complete set	nylon/steel	black	8 positions, 80 mm	n.a.	30°

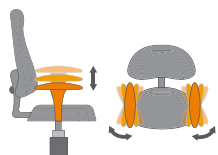

ARMRESTS

AR116-SET

- + complete set
- + rotatable arm pads
- + height adjustable
- + depth adjustable
- + width adjustable



Set of 4D armrests with pads and a specially developed bracket for mounting on ACP's large round stool seats. The armrests are easily adjustable to the desired height, and the pads are width-adjustable, rotatable, and depth-adjustable. This set is compatible only with stools used in combination with mechanisms SM514 and SM515.

	DESCRIPTION	MATERIAL	FINISH	HEIGHT ADJUSTMENT
AR116-SET	complete set	nylon/steel	black	8 positions, 80 mm



ARMRESTS

AR130

- + pair of armrests L + R
- + height adjustable

A basic pair 2D of armrests that can be easily adjusted to the desired height.

	DESCRIPTION	MATERIAL	FINISH	HEIGHT ADJUSTMENT	HOLE PATTERN
AR130	armrests (L+R)	nylon/steel	black	8 positions, 70 mm	55 x 55 (euro holes)
PU082	matching arm pad	polyurethane	black		84, 102

**Applicable part**

	DESCRIPTION	FINISH
PU082	arm pad	polyurethane



PU082

ARMRESTS

AR120

- + pair of armrests L + R
- + height adjustable
- + depth adjustable
- + width adjustable
- + including arm pads



A pair of 3D armrests that can be easily adjusted for both height and width. The included pads are adjustable in depth.

	DESCRIPTION	MATERIAL	FINISH	HEIGHT ADJUSTMENT
AR120	armrests (L+R)	nylon/steel	chrome	7 positions, 70 mm



Applicable parts

	DESCRIPTION	MATERIAL
AR120-B1	bracket for plate	steel
AR120-B2	bracket for mounting on seat	steel
AR120-KN	knob	nylon
AR908-B	arm bracket	steel
AR916-B	arm bracket	nylon



ARMRESTS

AR120-SET

- + complete set
- + for stools
- + height adjustable
- + depth adjustable
- + width adjustable



A set of 3D armrests with a specially developed bracket for mounting on ACP's large round seats. The armrests are easily adjustable for height and width, and the included pads are adjustable in depth. Compatible only with the SM515 mechanism.

	DESCRIPTION	MATERIAL	FINISH	HEIGHT ADJUSTMENT	WIDTH ADJUSTMENT
AR120-SET	complete set, for stools	nylon/steel	chrome	7 positions, 70 mm	7 positions, 70 mm
AR122-SET	complete set, for chairs	nylon/steel	chrome	7 positions, 70 mm	7 positions, 70 mm



ARMRESTS

AR135

- + pair of armrests L + R
- + height adjustable
- + width adjustable
- + rotatable arm pads



Pair of 4D armrests, easily adjustable for height and width.
The pads are included and can be rotated.

	DESCRIPTION	MATERIAL	FINISH	HEIGHT ADJUSTMENT
AR135	armrests (L+R)	nylon / aluminium	polished	10 positions, 100 mm

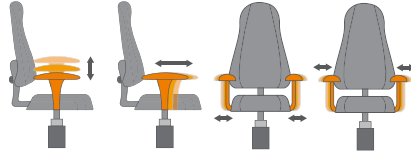
**Applicable part**

	DESCRIPTION	MATERIAL
AR905	mounting bracket for armrests AR135 and AR300	steel, black powder coating



ARMRESTS

AR300

- + pair of armrests L + R
- + height adjustable
- + width adjustable
- + rotatable arm pads



Pair of 4D armrests, easily adjustable for height and width.
The pads are included and are rotatable.

	DESCRIPTION	MATERIAL	FINISH	HEIGHT ADJUSTMENT
AR135	armrests (L+R)	nylon / aluminium	polished	10 positions, 100 mm

**Applicable part**

	DESCRIPTION	MATERIAL
AR905	mounting bracket for armrests AR135 and AR300	steel, black powder coating



ARMRESTS

PHLEBOTOMY ARMREST

The phlebotomy armrest is specifically designed for use with phlebotomy chairs, ensuring optimal comfort for patients during blood withdrawal. It features the following unique characteristics: adjustable for the perfect height, repositionable from left to right for flexible placement, and cleanable with 95% alcohol for hygienic maintenance. With the AR080-SET, healthcare professionals can work efficiently and comfortably, while patients receive the necessary support.



AR080-SET



DESCRIPTION

AR080-SET	Complete set, including: stainless steel armrest with armpad PU080 mounting bracket with clamp and turning knob
-----------	---

Applicable part

	DESCRIPTION	MATERIAL
AR916-SET	mounting plate	steel
AR120-B1	bracket for plate	steel
AR120-B2	bracket for mounting on seat	steel



AR916-SET



AR120-B1



AR120-B2



AR120-KN

ARMRESTS

PU082

	DESCRIPTION	MATERIAL	COLOUR	WIDTH	LENGTH	HOLE PATTERN
PU082	suitable for arm rest AR110, AR111, AR112, AR114, AR130	polyurethane	black	90	265	84, 102

**PU080**

Elongated arm pad suitable for phlebotomy chairs

	MATERIAL	COLOUR	LENGTH	WIDTH	HOLE PATTERN
PU080	polyurethane	black	350	115	100, 150



PU PARTS

PU209 | PU404

	DESCRIPTION	MATERIAL	COLOUR	WIDTH	HEIGHT / DEPTH	HOLE PATTERN
PU404	back rest	polyurethane with wooden inlay	black	385	370	98
PU209	seat	polyurethane with wooden inlay	black	440	425	214 / 30 x 172 220 / 96 x 150 170 x 200



Recommended mechanisms with back rest

	DESCRIPTION	FINISH
SM514	steel mechanism with fixed seating angle	black
SM515	steel mechanism with seat tilt, flat back bar	black



SM514

SM515

PU PARTS

PU225 | PU409

	DESCRIPTION	MATERIAL	COLOUR	WIDTH	HEIGHT / DEPTH	HOLE PATTERN
PU409	back rest	polyurethane with wooden inlay	black	370	250	98
PU225	seat	polyurethane with wooden inlay	black	410	385	214 / 30 x 172 220 / 96 x 150 170 x 200



Recommended mechanisms with back rest

	DESCRIPTION	FINISH
SM514	steel mechanism with fixed seating angle	black
SM515	steel mechanism with seat tilt, flat back bar	black
SM510	steel mechanism with seat tilt, oval back bar	black



SM514



SM515



SM510





PU PARTS

PU PARTS

PU238 | PU415

	DESCRIPTION	MATERIAL	COLOUR	WIDTH	HEIGHT / DEPTH	HOLE PATTERN
PU415	back rest	polyurethane with wooden inlay	black	400	300	98
PU238	seat	polyurethane with wooden inlay	black	455	425	214 / 30 x 172 220 / 96 x 150 170 x 200



Optional:
AR130
armrest

Recommended mechanisms with back rest

	DESCRIPTION	FINISH
SM514	steel mechanism with fixed seating angle	black
SM515	steel mechanism with seat tilt, flat back bar	black
SM510	steel mechanism with seat tilt, oval back bar	black



SM514



SM515



SM510

READY-TO-SEAT PRACTICAL PU

PU256

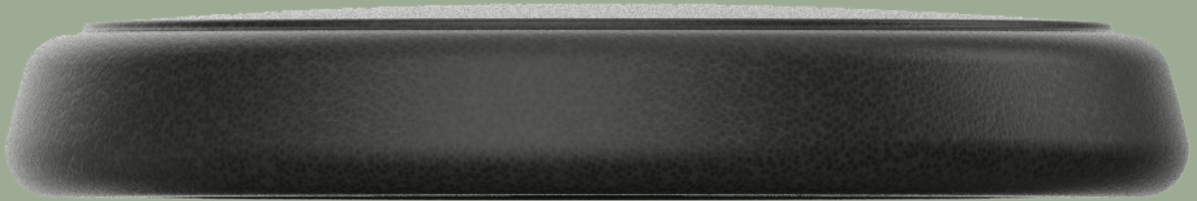

PU255



PU258

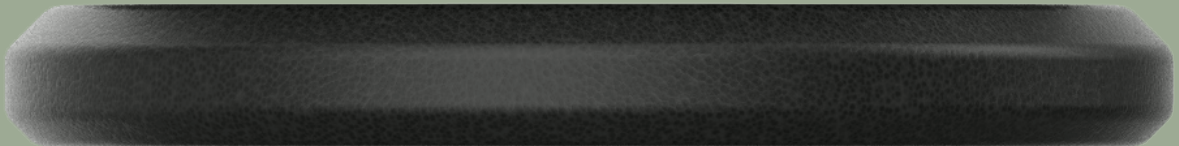

PU259

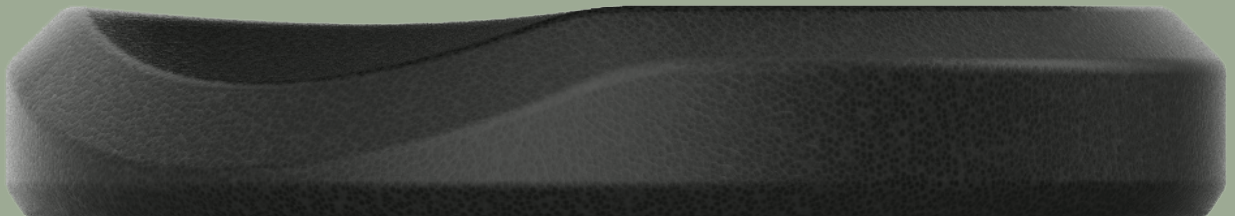

PU PART

PU266

We have developed a practical PU line of seats and backs for environments where hygiene is paramount, such as laboratories, clean rooms, and schools.

	DESCRIPTION	MATERIAL	COLOUR	Ø	HEIGHT	HOLE PATTERN
PU266	stool	polyurethane seat with wooden inlay	black	340	50	55 x 55 130 x 130

**Recommended mechanisms**

	DESCRIPTION	FINISH
SM001-A	steel mechanism with ring adjustment	black
SM005	aluminium mechanism with ring adjustment	black or polished



SM001-A



SM005-BB



SM005-PC

PU PART

PU255

	DESCRIPTION	MATERIAL	COLOUR	Ø	HEIGHT	HOLE PATTERN
PU255-B	round seat	polyurethane seat with wooden inlay	black	375	85	55 x 55 130 x 130

**Recommended mechanisms**

	DESCRIPTION	FINISH
SM001-A	steel mechanism with ring adjustment	black
SM005	aluminium mechanism with ring adjustment	black or polished



SM001-A



SM005-BB



SM005-PC

PU PART

PU256

	DESCRIPTION	MATERIAL	COLOUR	Ø	HEIGHT	HOLE PATTERN
PU256-B	stool	polyurethane seat with wooden inlay	black	365	60	55 x 55 130 x 130 220/96 x 150

**Recommended mechanisms**

	DESCRIPTION	FINISH
SM001-A	steel mechanism with ring adjustment	black
SM005	aluminium mechanism with ring adjustment	black or polished



SM001-A



SM005-BB



SM005-PC

Recommended mechanisms with back rest

	DESCRIPTION	FINISH
SM514	steel mechanism, fixed seating angle	black
SM515	steel mechanism, seat tilt, flat back bar	black



SM514



SM515

ERGONOMIC CONCAVE SHAPE



ERGONOMIC
DESIGN

PU258

Round seat made of durable polyurethane. The concave shape prevents slipping and enhances seating stability, improving contact when moving with the stool.



PU PART

PU258

The concave shape of this seat prevents slipping and enhances seating stability, even when moving with the stool while seated.

	DESCRIPTION	MATERIAL	COLOUR	Ø	HEIGHT	HOLE PATTERN
PU258-B	round seat	polyurethane seat with wooden inlay	black	365	45	55 x 55 130 x 130 220/96 x 150

**Recommended mechanisms**

	DESCRIPTION	FINISH
SM001-A	steel mechanism with ring adjustment	black
SM005	aluminium mechanism with ring adjustment	black or polished



SM001-A



SM005-BB



SM005-PC

Recommended mechanisms with back rest

	DESCRIPTION	FINISH
SM514	steel mechanism, fixed seating angle	black
SM515	steel mechanism, seat tilt, flat back bar	black



SM514



SM515

ERGONOMIC CONCAVE SHAPE

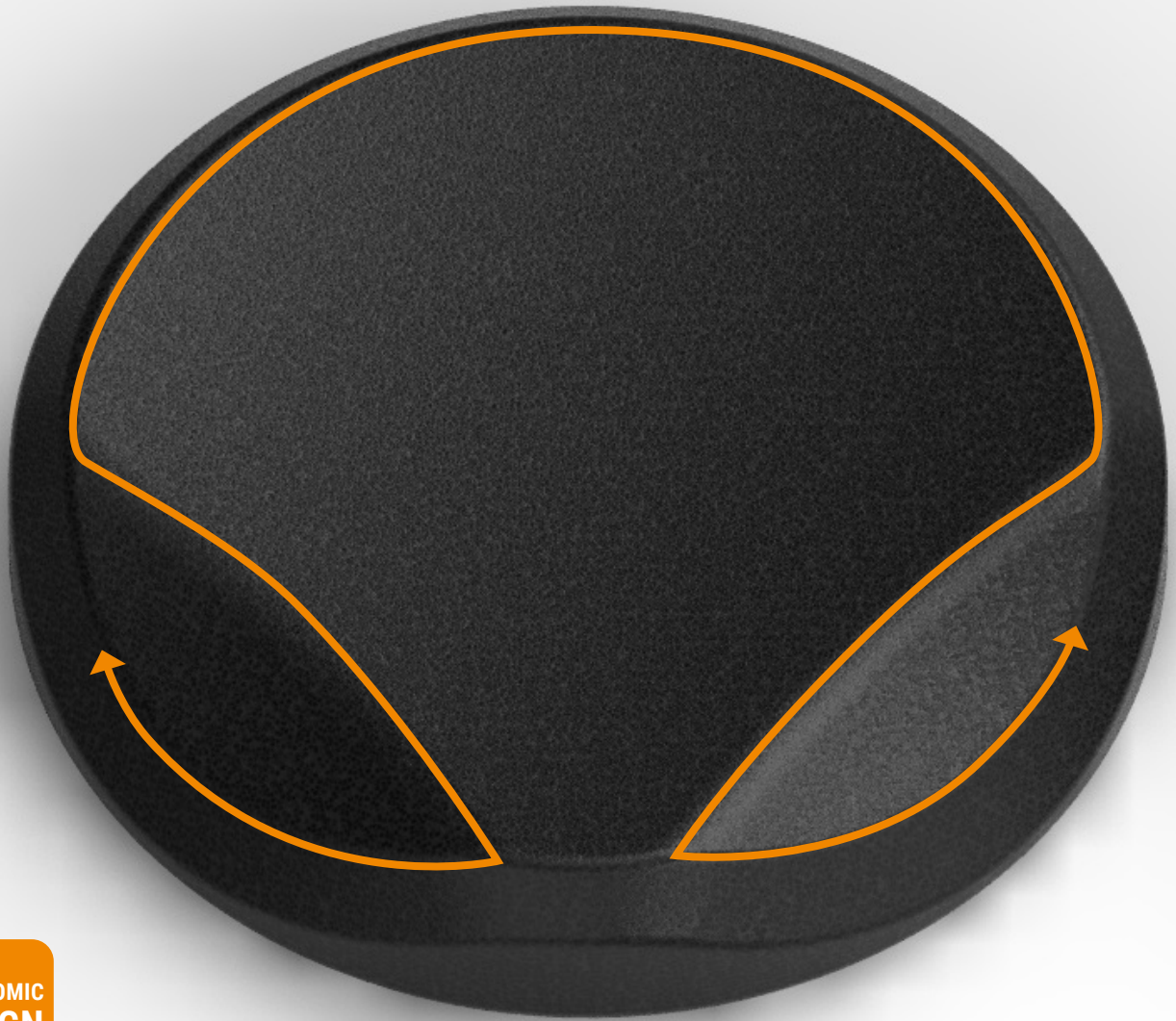

ERGONOMIC
DESIGN

PU259

The concave shape of this ergonomic seat promotes healthy seating posture and optimal comfort. The leg recesses prevent blood vessels from being pinched in an elevated sitting position.

PU PART

PU259

	DESCRIPTION	MATERIAL	COLOUR	Ø	HEIGHT	HOLE PATTERN
PU259-B	round seat	polyurethane seat with wooden inlay	black	380	67	55 x 55 130 x 130 220/96 x 150



Recommended mechanisms

	DESCRIPTION	FINISH
SM001-A	steel mechanism with ring adjustment	black
SM005	aluminium mechanism with ring adjustment	black or polished



SM001-A



SM005-BB



SM005-PC

Recommended mechanisms with back rest

	DESCRIPTION	FINISH
SM514	steel mechanism, fixed seating angle	black
SM515	steel mechanism, seat tilt, flat back bar	black



SM514



SM515

PU PARTS

PU201

PU seat with integrated cone and lever for height adjustment.

	DESCRIPTION	MATERIAL	COLOUR	Ø	HEIGHT
PU201	round seat	polyurethane with steel inlay	black	350	30

Cone and
lever
included



PU263

	DESCRIPTION	MATERIAL	COLOUR	Ø	HEIGHT	HOLE PATTERN
PU263	round seat	polyurethane with wooden inlay	black	355	25	55 x 55 130 x 130



Recommended mechanisms

	DESCRIPTION	FINISH
SM001-A	steel mechanism with ring adjustment	black
SM005	aluminium mechanism with ring adjustment	black or polished



SM001-A



SM005-BB



SM005-PC



PU PARTS

PU264

	DESCRIPTION	MATERIAL	COLOUR	Ø	HEIGHT	HOLE PATTERN
PU264	round seat	polyurethane with wooden inlay	black	345	30	55 x 55 130 x 130



PU265

	DESCRIPTION	MATERIAL	COLOUR	Ø	HEIGHT	HOLE PATTERN
PU265	round seat	polyurethane with wooden inlay	black	300	35	55 x 55 130 x 130



Small
diameter

Recommended mechanisms

	DESCRIPTION	FINISH
SM001-A	steel mechanism with ring adjustment	black
SM005	aluminium mechanism with ring adjustment	black or polished



SM001-A



SM005-BB



SM005-PC



PU PART

PU243

	DESCRIPTION	MATERIAL	COLOUR	WIDTH	DEPTH	HEIGHT	HOLE PATTERN
PU243-B	sit-stand seat	polyurethane with wooden inlay	black	330	250	170	100 x 100 140 x 140

Recommended mechanism

	DESCRIPTION	FINISH
SM305-A	steel mechanism, seat tilt	black



SM305-A



PU PARTS

PU215

	DESCRIPTION	MATERIAL	COLOUR	WIDTH	DEPTH	HEIGHT	HOLE PATTERN
PU215	sit-stand seat with handle	polyurethane with wooden inlay	black	360	310	130	100 x 100 140 x 140

Recommended mechanism

	DESCRIPTION	FINISH
SM305-A	steel mechanism, seat tilt	black



SM305-A



PU245

	DESCRIPTION	MATERIAL	COLOUR	WIDTH	DEPTH	HEIGHT	HOLE PATTERN
PU245-B	sit-stand seat for stools	polyurethane with wooden inlay	black	340	330	150	100 x 100 140 x 140

Recommended mechanism

	DESCRIPTION	FINISH
SM305-A	steel mechanism, seat tilt	black



SM305-A



CURVED SHAPE SPLIT-SADDLE

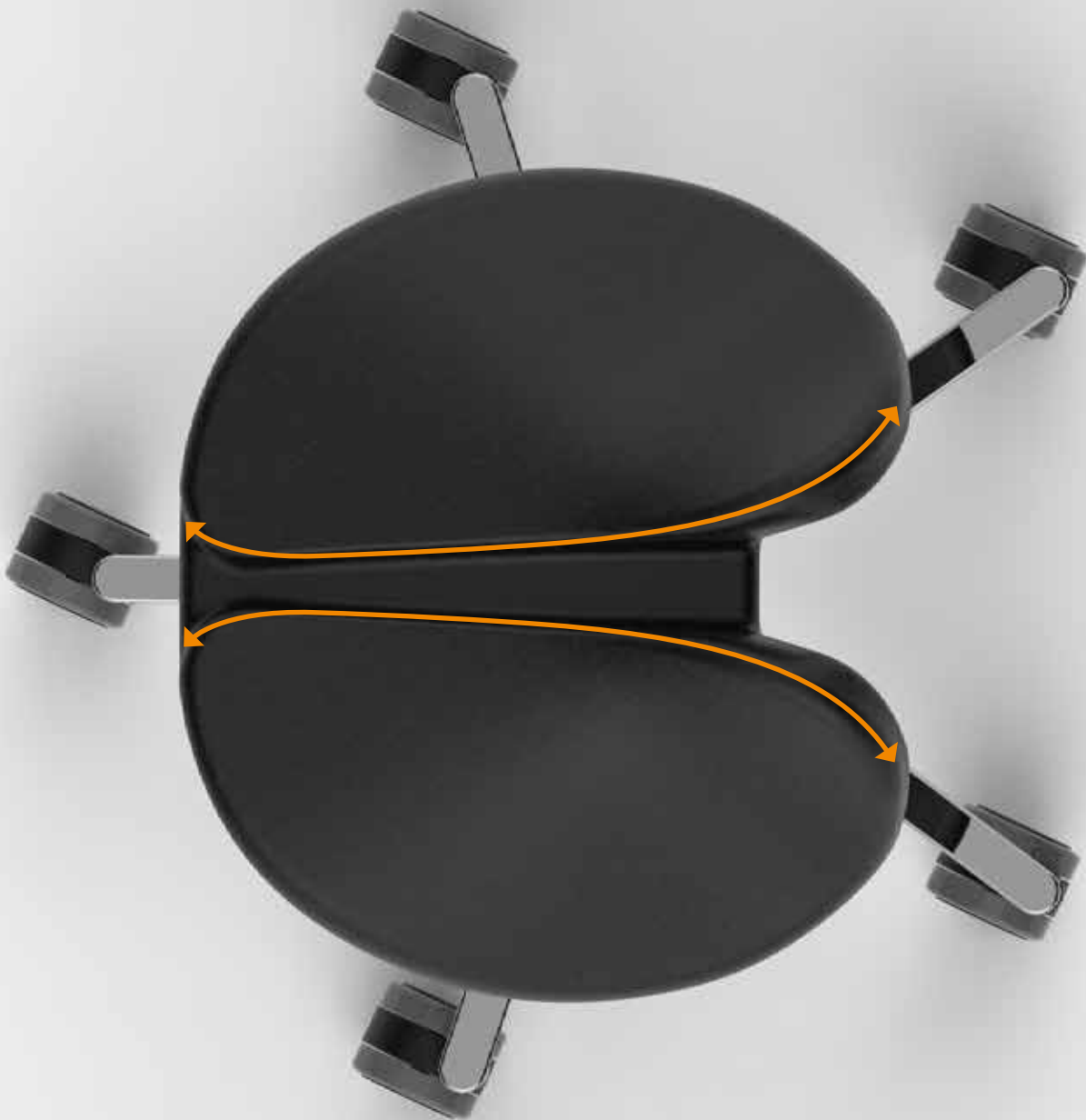

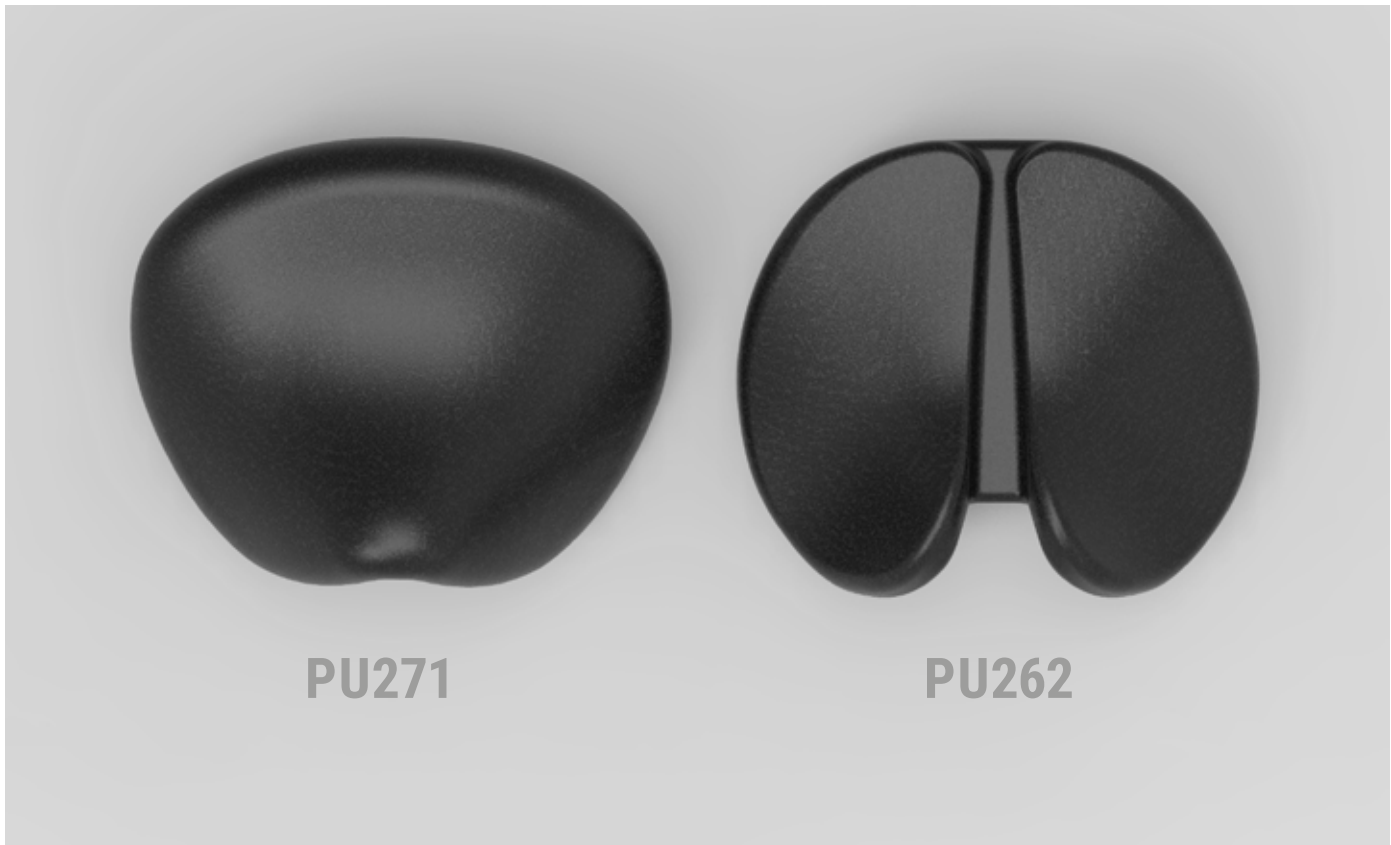

Saddle seats help to reduce painful pressure on the back and spine. We offer two types of polyurethane saddles: the standard PU271 version and the PU262 split-seat option. The PU262 features a central slot that minimizes unhealthy friction and pressure on the pelvic area while enhancing balance. Its curved shape is optimized for ergonomics, making it ideal for extended periods of sitting.

PU PART

PU271

	DESCRIPTION	MATERIAL	COLOUR	WIDTH	DEPTH	HOLE PATTERN
PU271-B	saddle	soft polyurethane with wooden inlay	black	410	330	55 x 55 93 x 100 138 x 138



Perfect
match with
FLEXLINE

**Recommended mechanisms**

	DESCRIPTION	FINISH
SM804	aluminium mechanism with lever adjustment	black or polished
SM305-A	steel mechanism, seat tilt	black



SM804-B



SM804-P



SM305-A

PU PART

PU262

	DESCRIPTION	MATERIAL	COLOUR	WIDTH	DEPTH	HOLE PATTERN
PU262	split saddle	soft polyurethane with wooden inlay	black	425	350	93 x 100 138 x 138



Perfect
match with
FLEXLINE

Recommended mechanisms

	DESCRIPTION	FINISH
SM804	aluminium mechanism with lever adjustment	black or polished
SM305-A	steel mechanism, seat tilt	black



SM804-B



SM804-P



SM305-A

PU PART

PU435

	DESCRIPTION	MATERIAL	COLOUR	WIDTH	HEIGHT	HOLE PATTERN
PU435-B	back rest	polyurethane with wooden inlay	black	340	238	96

**Applicable seats**

	DESCRIPTION	FINISH	SIZE
PU255-B	polyurethane stool	black	ø 375
PU256-B	polyurethane stool	black	ø 375
PU258-B	polyurethane round seat	black	ø 365
PU259-B	polyurethane stool	black	ø 380
PU271-B	polyurethane saddle	black	425 x 350
PU262	polyurethane saddle	black	425 x 350



PU271-B



PU262



PU255-B



PU256-B



PU258-B



PU259-B

PU PART

PU432

	DESCRIPTION	MATERIAL	COLOUR	WIDTH	HEIGHT / DEPTH	HOLE PATTERN
PU432-B	back rest	polyurethane with wooden inlay	black	430	120	92



Applicable seats

	DESCRIPTION	FINISH	SIZE
PU255-B	polyurethane stool	black	ø 375
PU256-B	polyurethane stool	black	ø 375
PU259-B	polyurethane stool	black	ø 380



PU255-B



PU256-B













PU259-B

MIX & MATCH

Find the matching mechanisms for each PU part

MIX & MATCH



	SM001-A	SM002	SM004-A	SM005	SM015	SM804	SM825	SM826
 PU255	•	•	•	•	•	•	•	•
 PU256	•	•	•	•	•	•	•	•
 PU258	•	•	•	•	•	•	•	•
 PU259	•	•	•	•	•	•	•	•
 PU263	•	•	•	•	•	•	•	•
 PU264	•	•	•	•	•	•	•	•
 PU265	•	•	•	•	•	•	•	•
 PU266	•	•	•	•	•	•	•	•
 PU215		•	•				•	•
 PU243		•	•				•	•
 PU245		•	•				•	•

MIX & MATCH



SM305-A	FLEXLINE	SM009
	•	•
	•	•
	•	•
	•	•
	•	•
	•	•
	•	•
	•	•
	•	•
•	•	•
•	•	•
•	•	•













MIX & MATCH

MIX & MATCH

Find the matching mechanisms for each PU part



MIX & MATCH

	SM001-A	SM002	SM004-A	SM005	SM015	SM804	SM825	SM826
 PU262			•				•	•
 PU271	•	•	•	•	•	•	•	•
 PU209 + PU404								
 PU225 + PU409								
 PU238 + PU415								
 PU255 + PU432								
 PU256 + PU432								
 PU255 + PU435								
 PU256 + PU435								
 PU271 + PU435								
 PU262 + PU435								

MIX & MATCH



SM514 / SM515	SM821	SM824	SM305-A	SM510	SM517	FLEXLINE	SM008	SM009
			•			•	•	
			•			•	•	•
•		•						
•		•		•				
•		•		•				
•								
•								
•	•	•						
•	•	•						
					•			
					•			

MIX & MATCH



DIRECT
FROM
STOCK

FOAM

FOAM PARTS

HIGH DENSITY FOAM

Our molded foam products are of high quality, durable, and designed for intensive use. They offer two main benefits: high density, which ensures a long lifespan, and excellent dimensional stability. These features give the upholstery a premium appearance and contribute to its durability.

New in our program

- PU294 seat with ergonomically shaped leg recesses
- PU296 a merge between a stool and a saddle seat
- PU270 the narrower version of a standard saddle seat
- PU300 leg rest

Most of our molded foam parts are also available with black artificial leather upholstery (page 164).



PU270



PU296



PU300



PU294

FOAM PART

PU248

	DESCRIPTION	MATERIAL	Ø	HEIGHT	HOLE PATTERN
PU248	round seat, soft	molded foam with wooden inlay	350	60	55 x 55 130 x 130
PU248-70	round seat, medium hard	molded foam with wooden inlay, 70 shore	350	60	55 x 55 130 x 130
PP320	seat cover	black polypropylene	320		

Available
soft and
medium
hard



Recommended mechanisms and applicable parts

	DESCRIPTION	FINISH
SM001-A	steel mechanism with ring adjustment	black
SM005	aluminium mechanism with ring adjustment	black or polished
PP320	matching seat cover	black



SM001-A



SM005-BB



SM005-PC



PP320

FOAM PART

PU257

	DESCRIPTION	MATERIAL	Ø	HEIGHT	HOLE PATTERN
PU257	round seat	molded foam with wooden inlay	400	70	55 x 55 135 x 135 220/96 x 150 220/28 x 170
PP360	seat cover	black polypropylene	360		



Recommended mechanisms and applicable parts

	DESCRIPTION	FINISH
SM001-A	steel mechanism with ring adjustment	black
SM005	aluminium mechanism with ring adjustment	black or polished
PP360	matching seat cover	black



SM001-A



SM005-BB



SM005-PC



PP360

FOAM PART

PU294

A round seat of molded foam, made of high-quality polyurethane, featuring leg recesses to provide improved comfort and reduced pressure on the legs.

	DESCRIPTION	MATERIAL	Ø	HEIGHT	HOLE PATTERN
PU294	round seat with recessed edges	molded foam with wooden inlay	400	70	55 x 55 135 x 135 220/96 x 150 220/28 x 170
PP360	seat cover	black polypropylene	360		

**Recommended mechanisms and applicable parts**

	DESCRIPTION	FINISH
SM001-A	steel mechanism with ring adjustment	black
SM005	aluminium mechanism with ring adjustment	black or polished
PP360	matching seat cover	black



SM001-A



SM005-BB



SM005-PC



PP360

FOAM PART

PU296

A combination of a round seat and a saddle seat, made of high-quality foam and featuring rounded leg recesses that help reduce pressure on the legs. This design enables comfortable seating for extended periods, even in a high sitting position.

	DESCRIPTION	MATERIAL	Ø	HEIGHT	HOLE PATTERN
PU296	ergonomically shaped saddle seat	molded foam with wooden inlay	420	80	55 x 55 135 x 135 220/96 x 150 220/28 x 170

**ERGONOMIC
DESIGN**
Recommended mechanisms

	DESCRIPTION	FINISH
SM001-A	steel mechanism with ring adjustment	black
SM005	aluminium mechanism with ring adjustment	black or polished



SM001-A



SM005-BB



SM005-PC

FOAM PART

PU291

	DESCRIPTION	MATERIAL	Ø	HEIGHT	HOLE PATTERN
PU291	round seat	molded foam with wooden inlay	370	70	55 x 55 130 x 130
PP320	seat cover	black polypropylene	320		



Recommended mechanisms and applicable parts

	DESCRIPTION	FINISH
SM001-A	steel mechanism with ring adjustment	black
SM005	aluminium mechanism with ring adjustment	black or polished
ME872	Flexline rubber adapter plate for stools	
SM005-RUB	Flexline rubber for 3D dynamic seating	
PP320	matching seat cover	black



SM001-A



SM005-BB



SM005-PC

ME872
SM005-RUB
SM005-PC

PP320

FOAM PART

PU300

This molded foam leg support is created for comfort and stability, ideal for foot care procedures or aiding recovery from injuries or medical treatments. Available as a single or double leg support, it ensures postural positioning to reduce strain and promote proper alignment. The leg support can be equipped with an adjustable mechanism, allowing the leg support angle to be customised for enhanced user comfort and flexibility.

	DESCRIPTION	MATERIAL	LENGTH	WIDTH	HOLE PATTERN
PU300	single leg support	molded foam with wooden inlay	400	230	100 x 100
PU300-KZ01	upholstered single leg support	molded foam with wooden inlay, black leatherette	400	230	100 x 100
PU301	double leg support	molded foam with wooden inlay	400	460	100 x 100
PU301-KZ01	upholstered double leg support	molded foam with wooden inlay, black leatherette	400	460	100 x 100

**Recommended mechanism**

	DESCRIPTION	FINISH
SM305-A	steel mechanism, seat tilt	black



SM305-A



FOAM PART

PU269

The molded foam saddle seat is made for optimal posture and comfort.
The cover has injected spacers, which makes separate spacers unnecessary.

	DESCRIPTION	MATERIAL	WIDTH	DEPTH	HOLE PATTERN
PU269-65	standard saddle	molded foam with wooden inlay	425	350	55 x 55 100 x 100
PP513	saddle cover	black polypropylene			55 x 55 100 x 100

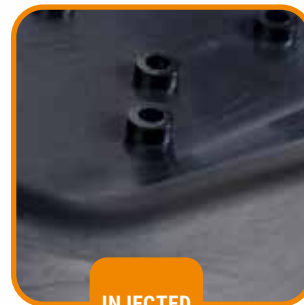

PP513

INJECTED
SPACERS

Recommended mechanisms and applicable parts

	DESCRIPTION	FINISH
SM804	aluminium mechanism with lever adjustment	black or polished
SM305-A	steel mechanism, seat tilt	black
PP513	matching seat cover	black



SM804-B



SM804-P



SM305-A



PP513

FOAM PART

PU270

The PU270 is a narrower version of the PU269, designed to accommodate smaller users. It pairs well with various types of back rests. The cover incorporates injected spacers, eliminating the need for separate spacers.

	DESCRIPTION	MATERIAL	WIDTH	DEPTH	HOLE PATTERN
PU270-65	medium saddle	molded foam with wooden inlay	360	340	55 x 55 100 x 100
PP270	medium saddle cover	black polypropylene			55 x 55 100 x 100



PP270



Recommended mechanisms and applicable parts

	DESCRIPTION	FINISH
SM804	aluminium mechanism with lever adjustment	black or polished
SM305-A	steel mechanism, seat tilt	black
PP270	matching seat cover	black



SM804-B

SM804-P

SM305-A

PP270

SHORE

THE SQUISHABILITY OF FOAM



Shore is the unit of measurement used to indicate the hardness of a material. The Durometer is used to measure the hardness of foam products. All of our foam parts for upholstery are made of high-quality polyurethane, with a softness ranging from 50° to 70° Shore F. In general, foam parts are equipped with a plywood inlay featuring threaded inserts.

FOAM PART

PU260

The PU260 is the narrowest saddle seat in our range, offering exceptional comfort for a low seating position. It is ideal for applications that require compact seating with reliable support. For a neat finish after upholstering, a metal plate is available to cover the staples.

	DESCRIPTION	MATERIAL	WIDTH	DEPTH	HOLE PATTERN
PU260	small saddle	molded foam with plastic inlay	325	335	55 x 55 100 x 100
ME260-B	seat cover	steel plate, black	325	335	55 x 55 100 x 100, 130 x 130

**Recommended mechanisms and applicable parts**

	DESCRIPTION	FINISH
SM804	aluminium mechanism with lever adjustment	black or polished
SM305-A	steel mechanism, seat tilt	black
ME260-B	matching seat cover	black



SM804-B



SM804-P



SM305-A

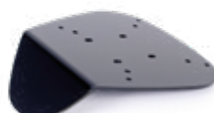

ME260-B

FOAM PART

PU288

BIKER



FOAM PART

PU288

The PU288 is an ergonomically shaped 'bicycle saddle' seat, ideal for applications where sitting and movement go hand in hand, such as in hair salons. The seat is made from durable molded foam that provides a soft feel. Its compact design ensures it takes up minimal space, so when combined with a small base, it fits effortlessly into any room. The PU288 is also available in black artificial leather (PU288-KZ01).

	DESCRIPTION	MATERIAL	WIDTH	DEPTH	HOLE PATTERN
PU288	biker saddle	molded foam	340	375	55 x 55 100 x 100

**Recommended mechanisms and applicable parts**

	DESCRIPTION	FINISH
SM804	aluminium mechanism with lever adjustment	black or polished
ME871	adapter plate for saddle seats	
SM305-A	steel mechanism, seat tilt	black
PP907	wedge for 3° tilting	black



SM804-B



SM804-P



SM305-A



PP907

FOAM PART

PU438

	DESCRIPTION	MATERIAL	WIDTH	HEIGHT	HOLE PATTERN
PU438	back rest	molded foam with wooden inlay	407	130	90

NEW



Applicable molded foam parts

	DESCRIPTION	Ø / WIDTH	HEIGHT
PU257	round seat	400	70
PU294	round seat with recessed legs	400	70
PU296	ergonomic shaped saddle	420	80



PU296



PU257



PU294

FOAM PART

PU431

	DESCRIPTION	MATERIAL	WIDTH	HEIGHT	HOLE PATTERN
PU431	back rest	molded foam with wooden inlay	345	100	90 - 102



Applicable molded foam parts

	DESCRIPTION	Ø / WIDTH	HEIGHT
PU248	round seat	350	60
PU291	round seat	370	70



PU248



PU291

FOAM PART

PU434

	DESCRIPTION	MATERIAL	WIDTH	HEIGHT	HOLE PATTERN
PU434	back rest	molded foam with wooden inlay	488	70	100 (3x)



Applicable molded foam parts

	DESCRIPTION	Ø / WIDTH	HEIGHT
PU257	round seat for upholstery	400	70
PU294	round seat with recessed legs	400	70
PU296	ergonomic shaped saddle	420	80



PU296



PU257



PU294

FOAM PART

PU436

	DESCRIPTION	MATERIAL	WIDTH	HEIGHT	HOLE PATTERN
PU436	back rest	molded foam with wooden inlay	340	238	96



Applicable molded foam parts

	DESCRIPTION	Ø / WIDTH	HEIGHT
PU248	round seat for upholstery	350	60
PU291	round seat for upholstery	370	70
PU257	round seat for upholstery	400	70
PU294	round seat with recessed legs	400	70
PU296	ergonomic shaped saddle	420	80
PU260	small saddle for upholstery	325	335
PU270	medium saddle for upholstery	365	350
PU269	standard saddle for upholstery	425	350



PU248



PU291



PU257



PU294



PU296



PU260



PU270



PU269

FOAM PART

PU437

One of our most comfortable back rests. Designed together with a very durable back cover.

	DESCRIPTION	MATERIAL	WIDTH	HEIGHT	HOLE PATTERN
PU437	back rest	molded foam with wooden inlay	357	256	92
PP437	back rest cover	black polypropylene			

NEW



Applicable molded foam parts

	DESCRIPTION	Ø / WIDTH	HEIGHT
PU248	round seat for upholstery	350	60
PU291	round seat for upholstery	370	70
PU257	round seat for upholstery	400	70
PU294	round seat with recessed legs	400	70
PU296	ergonomic shaped saddle	420	80
PU260	small saddle for upholstery	325	335
PU270	medium saddle for upholstery	365	350
PU269	standard saddle for upholstery	425	350



PU248



PU291



PU257



PU294



PU296



PU260



PU270



PU269

FOAM PART

PU439

	DESCRIPTION	MATERIAL	WIDTH	HEIGHT	HOLE PATTERN
PU439	back rest	molded foam with wooden inlay	385	233	90
PP439	cover	black polypropylene	385	233	90



Applicable molded foam parts

	DESCRIPTION	Ø / WIDTH	HEIGHT
PU248	round seat for upholstery	350	60
PU291	round seat for upholstery	370	70
PU257	round seat for upholstery	400	70
PU294	round seat with recessed legs	400	70
PU296	ergonomic shaped saddle	420	80
PU260	small saddle for upholstery	325	335
PU270	medium saddle for upholstery	365	350
PU269	standard saddle for upholstery	425	350



PU248



PU291



PU257



PU294



PU296



PU260



PU270



PU269

FOAM PART

PU425

	DESCRIPTION	MATERIAL	WIDTH	HEIGHT	HOLE PATTERN
PU425	back rest	molded foam with wooden inlay	215	260	94



Applicable molded foam parts

	DESCRIPTION	Ø / WIDTH	HEIGHT
PU248	round seat for upholstery	350	60
PU291	round seat for upholstery	370	70
PU257	round seat for upholstery	400	70
PU294	round seat with recessed legs	400	70
PU296	ergonomic shaped saddle	420	80
PU260	small saddle for upholstery	325	335
PU270	medium saddle for upholstery	365	350
PU269	standard saddle for upholstery	425	350



PU248



PU291



PU257



PU294



PU296



PU260



PU270



PU269

FOAM PART

PU331

The PU331 is a new medium high back rests with a ergonomic design.

	DESCRIPTION	MATERIAL	WIDTH	HEIGHT	HOLE PATTERN
PU331	medium back rest	molded foam	400	380	
PP331	inner back, medium	black polypropylene	395	370	100 x 30
PP331-KAP	back cover, medium	black polypropylene	400	380	



PU332

The PU332 is a new high back rests with a ergonomic design.

	DESCRIPTION	MATERIAL	WIDTH	HEIGHT	HOLE PATTERN
PU332	high back rest	molded foam	420	485	
PP332	inner back, high	black polypropylene	415	480	100 x 30
PP332-KAP	back cover, high	black polypropylene	420	485	



Matching back bars

	DESCRIPTION	FINISH	LENGTH
AS636	steel back bar, bended 90°	black	400
AS540	oval steel back bar with plate	black	425
AS655-B	flat metal back bar with plate	black	460



AS636

AS540

AS655-B



PP332-KAP

PP332











PU332

MIX & MATCH

Find the matching mechanisms for each foam part



MIX & MATCH

	SM001-A	SM002	SM004-A	SM005	SM015	SM804	SM825	SM826
 PU248	•	•	•	•	•	•	•	•
 PU257	•	•	•	•	•	•	•	•
 PU260						•		
 PU269						•		
 PU270						•		
 PU291	•	•	•	•	•	•	•	•
 PU294	•	•	•	•	•	•	•	•
 PU296	•	•	•	•	•	•	•	•
 PU288	•	•	•	•	•	•		
 PU300 / PU301								

MIX & MATCH



SM305-A	FLEXLINE	FLEXLINE	SM008	SM009
		•		•
		•		
•	•		•	•
•	•		•	
•	•		•	
		•		•
		•		
		•		
•				











MIX & MATCH

MIX & MATCH

Find the matching mechanisms for each foam part





























MIX & MATCH

	SM821	SM514	SM515	AS646
 PU248 + PU431	•			
 PU291 + PU431	•			
 PU257 + PU438		•	•	
 PU294 + PU438		•	•	
 PU296 + PU438		•	•	
 PU257 + PU434				•
 PU294 + PU434				•
 PU296 + PU434				•



MIX & MATCH







	SM821	SM514	SM515	SM517		SM514	SM515	SM517
  PU291 + PU436	•				  PU257 + PU439	•	•	
  PU257 + PU436		•	•		  PU294 + PU439	•	•	
  PU294 + PU436		•	•		  PU296 + PU439	•	•	
  PU296 + PU436		•	•		  PU260 + PU439			•
  PU260 + PU436				•	  PU269 + PU439			•
  PU269 + PU436				•	  PU270 + PU439			•
  PU270 + PU436				•				

MIX & MATCH

MIX & MATCH

Find the matching mechanisms for each foam part









MIX & MATCH

	SM514	SM515	SM517
 PU257 + PU437	•	•	
 PU294 + PU437	•	•	
 PU296 + PU437	•	•	
 PU260 + PU437	•	•	•
 PU269 + PU437	•	•	•
 PU270 + PU437	•	•	•



MIX & MATCH



	SM821	SM514	SM515	SM517
 <p>PU248 + PU425</p>	•			
 <p>PU291 + PU425</p>	•			
 <p>PU257 + PU425</p>		•	•	
 <p>PU294 + PU425</p>		•	•	
 <p>PU296 + PU425</p>		•	•	
 <p>PU260 + PU425</p>				•
 <p>PU269 + PU425</p>				•
 <p>PU270 + PU425</p>				•



MIX & MATCH

UPHOLSTERED



UPHOLSTERY

PARTS

**DIRECT
FROM
STOCK**

For many of our customers, we supply molded foam parts upholstered in durable leatherette, making it easier than ever to assemble your own chair in just a few minutes. For any questions about upholstered parts or the different colours and materials available, feel free to reach out! **Just Ask!**

New in our range

- Wave seat with ergonomically shaped leg recesses
- Ergo seat, a combination of a stool and saddle seat
- Saddle Medium the narrower version of a standard saddle seat
- Leg suport single or double leg support



UPHOLSTERED PART

WAVE

A round seat made of molded foam, upholstered in durable leatherette.
The leg recesses help reduce pressure on the legs and provide superior support.

	DESCRIPTION	MATERIAL	Ø	HEIGHT	HOLE PATTERN
PU294-KZ01	round seat with recessed legs	molded foam with wooden inlay, upholstered with black leatherette	400	70	55 x 55 135 x 135 220/96 x 150 220/28 x 170

**ERGONOMIC
DESIGN**

**Recommended mechanisms and applicable parts**

	DESCRIPTION	FINISH
SM001-A	steel mechanism with ring adjustment	black
SM005	aluminium mechanism with ring adjustment	black or polished
PP360	matching seat cover	black



SM001-A



SM005-BB



SM005-PC



PP360

UPHOLSTERED PART

ERGO

A combination of a round seat and a saddle seat, made of high-quality foam and upholstered in durable leatherette. It features rounded leg recesses that help reduce pressure on the legs, enabling comfortable seating for extended periods, even in a high sitting position.

	DESCRIPTION	MATERIAL	Ø	HEIGHT	HOLE PATTERN
PU296-KZ01	ergonomic shaped saddle	molded foam with wooden inlay, upholstered with black leatherette	420	80	55 x 55 135 x 135 220/96 x 150 220/28 x 170

**ERGONOMIC
DESIGN**
**Recommended mechanisms**

	DESCRIPTION	FINISH
SM001-A	steel mechanism with ring adjustment	black
SM005	aluminium mechanism with ring adjustment	black or polished



SM001-A



SM005-BB



SM005-PC



UPHOLSTERED PART

SEAT 350

	DESCRIPTION	MATERIAL	Ø	HEIGHT	HOLE PATTERN
PU248-KZ01	round seat	molded foam with wooden inlay, upholstered with black leatherette	350	60	55 x 55 130 x 130

**Recommended mechanisms and applicable parts**

	DESCRIPTION	FINISH
SM001-A	steel mechanism with ring adjustment	black
SM005	aluminium mechanism with ring adjustment	black or polished
PP320	matching seat cover	black



SM001-A



SM005-PC



SM001-A



PP320

SEAT 400

	DESCRIPTION	MATERIAL	Ø	HEIGHT	HOLE PATTERN
PU257-KZ01	round seat	molded foam with wooden inlay, upholstered with black leatherette	400	70	55 x 55 135 x 135 220/96 x 150 220/28 x 170

**Recommended mechanisms and applicable parts**

	DESCRIPTION	FINISH
SM001-A	steel mechanism with ring adjustment	black
SM005	aluminium mechanism with ring adjustment	black or polished
PP360	matching seat cover	black



SM001-A



SM005-PC



SM001-A



PP360

UPHOLSTERED PART

SADDLE S

This saddle is the narrowest version in our range and offers unique comfort. It is commonly chosen for situations where a higher seating position is preferred.

	DESCRIPTION	MATERIAL	WIDTH	DEPTH	HOLE PATTERN
PU260-KZ01	small saddle	molded foam with plastic inlay, upholstered with black leatherette	325	335	55 x 55 100 x 100



Recommended mechanisms and applicable parts

	DESCRIPTION	FINISH
SM804	aluminium mechanism with lever adjustment	black or polished
SM005	aluminium mechanism with ring adjustment	black or polished
ME871	adapter plate for saddle seats	
SM005-RUB	Flexline rubber for 3D dynamic seating	
SM305-A	steel mechanism, seat tilt	black
ME260-B	matching seat cover	black



SM804-B



SM804-P



SM005-BB



SM005-PC

ME871
SM005-RUB
SM005-BB

SM305-A

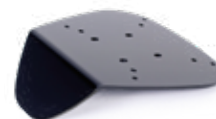

ME260-B

UPHOLSTERED PART

SADDLE M

This narrower version of our PU269 is suited for women and smaller individuals and pairs well with various types of backrests.

	DESCRIPTION	MATERIAL	WIDTH	DEPTH	HOLE PATTERN
PU270-65-KZ01	medium saddle	molded foam with wooden inlay, upholstered with black leatherette	360	346	55 x 55 100 x 100

	DESCRIPTION	MATERIAL	HOLE PATTERN
PP270	medium saddle cover	black polypropylene	55 x 55 100 x 100

**Recommended mechanisms**

	DESCRIPTION	FINISH
SM804	aluminium mechanism with lever adjustment	black or polished
SM005	aluminium mechanism with ring adjustment	black or polished
ME871	adapter plate for saddle seats	
SM005-RUB-B	Flexline rubber for 3D dynamic seating	
SM305-A	steel mechanism, seat tilt	black
SM517	steel mechanism, independent back- and seat angle adjustment	black
PP270	matching seat cover	black



PP270



SM804-B



SM804-P



SM005-BB



SM005-PC

ME871
SM005-RUB-B
SM005-BB

SM305-A



SM517

UPHOLSTERED PART

SADDLE ST

Standard molded foam saddle seat, upholstered in black leatherette.

	DESCRIPTION	MATERIAL	WIDTH	DEPTH	HOLE PATTERN
PU269-65-KZ01	standard saddle	molded foam with wooden inlay, upholstered with black leatherette	425	353	55 x 55 100 x 100

	DESCRIPTION	MATERIAL	HOLE PATTERN
PP513	saddle cover	black polypropylene	55 x 55 100 x 100

**Recommended mechanisms**

	DESCRIPTION	FINISH
SM804	aluminium mechanism with lever adjustment	black or polished
SM005	aluminium mechanism with ring adjustment	black or polished
ME871	adapter plate for saddle seats	
SM005-RUB-B	Flexline rubber for 3D dynamic seating	
SM305-A	steel mechanism, seat tilt	black
SM517	steel mechanism, independent back- and seat angle adjustment	black
PP513	matching seat cover	black



PP513



SM804-B



SM804-P



SM005-BB



SM005-PC

ME871
SM005-RUB-B
SM005-BB

SM305-A



SM517

UPHOLSTERED PART

CUSTOM UPHOLSTERY

Most of our molded foam parts are available in stock, upholstered in black leatherette. Want to create a custom look with a different type of upholstery? It's definitely possible, even for small quantities! **Just Ask!**



UPHOLSTERY

UPHOLSTERED PART

PU288

The PU288 is an ergonomically shaped 'bicycle saddle' seat, perfect for various applications where sitting and movement go hand in hand, such as in hair salons. The PU288 is upholstered in black leatherette (PU288-KZ01).

	DESCRIPTION	MATERIAL	WIDTH	DEPTH	HOLE PATTERN
PU288-KZ01	biker saddle	molded foam with black upholstered leatherette	340	375	55 x 55 100 x 100

**Recommended mechanisms and applicable parts**

	DESCRIPTION	FINISH
SM804	aluminium mechanism with lever adjustment	black or polished
SM305-A	steel mechanism with seat tilt	black
PP907	wedge for 3° tilting	black



SM804-B



SM804-P



SM305-A



PP907

UPHOLSTERED PART

CHAIR

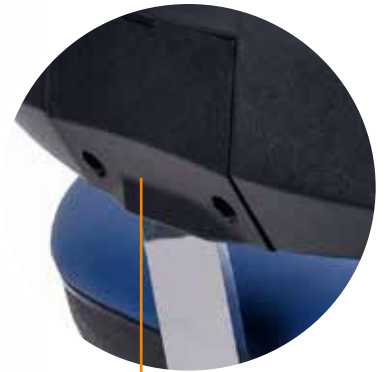

PP329

UPHOLSTERY

UPHOLSTERED PART

CHAIR

The PU329-Z (seat) and PU329-R (back rest) form a set of upholstered foam components, enabling you to create your own chair. Both the seat and back rest are ergonomically designed to provide optimal support and are available in a range of colours and materials. The seat can be paired with the AR130 armrest and compatible ACP mechanisms, including the SM510, SM514, and SM515. A plastic cover for both the seat and back rest is included.

	DESCRIPTION	MATERIAL	FINISH	LENGTH /HEIGHT	WIDTH
PU329-Z-KZ01	seat	foam with wooden inlay	black leatherette	450	480
PU329-R-KZ01	back rest	foam with nylon inlay	black leatherette	400	420
PU329-Z-KZ02	seat	foam with wooden inlay	white leatherette	450	480
PU329-R-KZ02	back rest	foam with nylon inlay	white leatherette	400	420
PU329-Z-KZ40	seat	foam with wooden inlay	blue leatherette	450	480
PU329-R-KZ40	back rest	foam with nylon inlay	blue leatherette	400	420

	DESCRIPTION	MATERIAL	FINISH	LENGTH /HEIGHT	WIDTH
PU329-Z-FM01	seat	foam with wooden inlay	black fabric	450	480
PU329-R-FM01	back rest	foam with nylon inlay	black fabric	400	420
PU329-Z-FM40	seat	foam with wooden inlay	blue fabric	450	480
PU329-R-FM40	back rest	foam with nylon inlay	blue fabric	400	420

**Recommended mechanisms and applicable parts**

	DESCRIPTION	FINISH
SM514	steel mechanism, fixed seating angle	black
SM515	steel mechanism, seat tilt, flat back bar	black
SM510	steel mechanism, seat tilt, oval back bar	black
PP329	back bar cover	black



UPHOLSTERED PART

BACK REST

	DESCRIPTION	MATERIAL	WIDTH	HEIGHT	HOLE PATTERN
PU436-KZ01	back part	molded foam with wooden inlay, upholstered with black leatherette	340	235	96

**Applicable upholstered parts**

	DESCRIPTION		DESCRIPTION
ERGO	PU296-KZ01 upholstered ergonomic shaped saddle, black leatherette	SADDLE S	PU260-65-KZ01 upholstered small saddle, black leatherette
WAVE	PU294-KZ01 upholstered round seat with recessed legs, black leatherette	SADDLE M	PU270-65-KZ01 upholstered medium saddle, black leatherette
SEAT 350	PU248-KZ01 upholstered round seat, black leatherette	SADDLE ST	PU269-65-KZ01 upholstered standard saddle, black leatherette
SEAT 400	PU257-KZ01 upholstered round seat, black leatherette		



PU296-KZ01



PU294-KZ01



PU248-KZ01



PU257-KZ01



SADDLE S, PU260-65-KZ01



SADDLE M, PU270-65-KZ01



SADDLE ST, PU269-65-KZ01

UPHOLSTERED PART

BACK REST

	DESCRIPTION	MATERIAL	WIDTH	HEIGHT	HOLE PATTERN
PU437-KZ01	back part	molded foam with wooden inlay, upholstered with black leatherette	357	256	92



Applicable upholstered parts

	DESCRIPTION
ERGO PU296-KZ01	upholstered ergonomic shaped saddle, black leatherette
WAVE PU294-KZ01	upholstered round seat with recessed legs, black leatherette
SEAT 350 PU248-KZ01	upholstered round seat, black leatherette
SEAT 400 PU257-KZ01	upholstered round seat, black leatherette

	DESCRIPTION
SADDLE S PU260-65-KZ01	upholstered small saddle, black leatherette
SADDLE M PU270-65-KZ01	upholstered medium saddle, black leatherette
SADDLE ST PU269-65-KZ01	upholstered standard saddle, black leatherette



PU296-KZ01



PU294-KZ01



PU248-KZ01



PU257-KZ01



SADDLE S, PU260-65-KZ01



SADDLE M, PU270-65-KZ01



SADDLE ST, PU269-65-KZ01

UPHOLSTERED PART

CURVED BACK REST

	DESCRIPTION	MATERIAL	WIDTH	HEIGHT	HOLE PATTERN
PU431-KZ01	lumbar support	molded foam with wooden inlay, upholstered with black leatherette	345	100	90 - 102

**Applicable upholstered parts**

	DESCRIPTION
SEAT 350 PU248-KZ01	upholstered round seat, black leatherette



PU248-KZ01

UPHOLSTERED PART

CURVED BACK REST

	DESCRIPTION	MATERIAL	WIDTH	HEIGHT	HOLE PATTERN
PU438-KZ01	lumbar support	molded foam with wooden inlay, upholstered with black leatherette	407	130	90

**Applicable upholstered parts**

	DESCRIPTION
ERGO PU296-KZ01	ergonomic shaped saddle upholstered with black leatherette
WAVE PU294-KZ01	round seat with recessed legs upholstered with black leatherette
SEAT 400 PU257-KZ01	round seat upholstered with black leatherette



PU296-KZ01



PU294-KZ01



PU257-KZ01

UPHOLSTERED PART

FLEXLINE BACKREST

	DESCRIPTION	MATERIAL	WIDTH	HEIGHT	HOLE PATTERN
PU434-KZ01	back rest	molded foam with wooden inlay, upholstered with black leatherette	488	70	100 (3x)



Applicable upholstered parts

	DESCRIPTION
ERGO PU296-KZ01	ergonomic shaped saddle upholstered with black leatherette
WAVE PU294-KZ01	round seat with recessed legs upholstered with black leatherette
SEAT 400 PU257-KZ01	round seat upholstered with black leatherette



PU296-KZ01



PU294-KZ01



PU257-KZ01

UPHOLSTERED PART

LEG SUPPORT

This molded foam part, upholstered with black leatherette, provides leg support. Available as both a single and double leg support, it is commonly used for foot care and to assist in the recovery of leg injuries.

	DESCRIPTION	MATERIAL	LENGTH	WIDTH	HOLE PATTERN
PU300-KZ01	single leg support	molded foam with wooden inlay, upholstered with black leatherette	400	230	100 x 100
PU301-KZ01	double leg support	molded foam with wooden inlay, upholstered with black leatherette	400	460	100 x 100

**Recommended mechanism**

	DESCRIPTION	FINISH
SM305-A	steel mechanism with seat tilt	black



SM305-A





WOOD

WOODEN PARTS

WP140 | WP444

	DESCRIPTION	MATERIAL	WIDTH	DEPTH	HEIGHT	HOLE PATTERN
WP444	seat	beech, varnished	440	402	9	220/96 x 150
WP140	back rest	beech, varnished	396	243	9	92



Recommended mechanisms and applicable parts

	DESCRIPTION	FINISH
SM514	steel mechanism with fixed seating angle	black
SM515	steel mechanism with seat tilt	black
SCH-FM-M6	flange nut	black



SM514



SM515



SCH-FM-M6



WOODEN PARTS

WOODEN PART

WP430

The WP340 comes without a hole pattern, making it versatile for mounting on any base, such as a steel 4-leg frame.

	DESCRIPTION	MATERIAL	Ø	HEIGHT
WP430	round seat	beech, varnished	340	9

**WP434**

	DESCRIPTION	MATERIAL	Ø	HEIGHT	HOLE PATTERN
WP434	round seat	beech, varnished	340	11	55 x 55

**Recommended mechanisms and applicable parts**

	DESCRIPTION	FINISH
SM804	steel mechanism with lever adjustment	black or polished
SM005	aluminium mechanism with ring adjustment	black or polished
SCH-FM-M6	flange nut	black



SM804-B



SM804-P



SM005-BB



SM005-PC



SCH-FM-M6

POSITION & SUPPORT

PP809 | PP811

Inflatable lumbar support supplied with air hose. A hand pump can be ordered separately.



	MATERIAL	WIDTH	HEIGHT	HOSE
PP809	polyurethane	300	150	750
PP811	polyurethane	400	200	750

Applicable parts

PP818	hand pump, round model
PP819	hand pump, flat model

PP810

Inflatable lumbar support with a 'dog bone' air chamber and air hose. A hand pump can be ordered separately.



	MATERIAL	WIDTH	HEIGHT	HOSE
PP810	polyurethane	300	150	750

Applicable parts

PP818	hand pump, round model
PP819	hand pump, flat model

PP813

Inflatable lumbar support with 3 separate air chambers and air hose. A hand pump can be ordered separately.



	MATERIAL	WIDTH	HEIGHT	HOSE
PP813	polyurethane	300	300	750

Applicable parts

PP825	hand pump, round model
PP823	hand pump, flat model

PP814

Inflatable lumbar support with 3 connected air chambers and air hose. A hand pump can be ordered separately.



	MATERIAL	WIDTH	HEIGHT	HOSE
PP814	polyurethane	300	300	750

Applicable parts

PP818	hand pump, round model
PP819	hand pump, flat model

Lumbar support
in customised
designs or shapes
on request!
Just Ask!

POSITION & SUPPORT

PUMPS

Hand pumps for inflating a pneumatic lumbar support. With the integrated drain valve, the air can be drained from the lumbar support. The hand pump is equipped with a \varnothing 6 mm hose socket.

Lumbar support
in customised
designs or shapes
on request!
Just Ask!

	DESCRIPTION	MATERIAL
PP818	hand pump, round model, suitable for a \varnothing 6 mm air hose	rubber
PP825	hand pump, 3 valves, round model with a \varnothing 6 mm air hose	rubber
PP831	clip for hand pump	rubber



PP818



PP825



PP831



**YOUR SUPPLIER OF COMPONENTS
FOR FURNITURE & INDUSTRY**

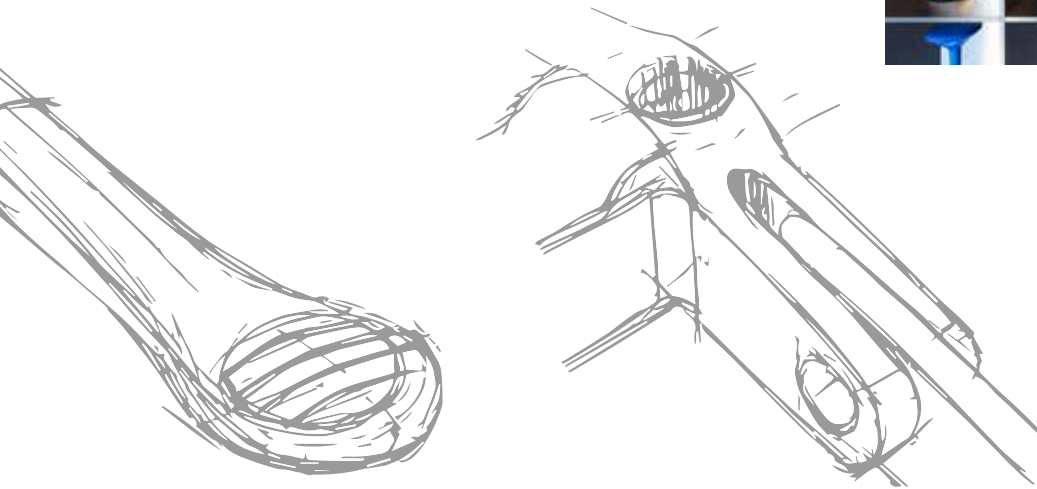



For over 40 years, ACP International has been a trusted supplier of components for office chairs, home furniture, and industrial applications. We see it as our responsibility to keep a close eye on developments and innovations in the area of components for furniture and incorporate a leadership role.

Our products are crafted from high-quality, durable materials, designed for long-term use and challenging conditions. Thanks to our relentless pursuit of reliable, long-lasting components, we offer a 10-year warranty on most of our products.

To enhance customer value, we have expanded our service offerings to include tailored solutions such as custom knock-down packing and specialized assembly services for castors, mechanisms, and gas cylinders. At ACP, we strive to make exceptional service the standard. **For any service inquiries, Just Ask!**



GASSPRINGS.EU SPECIALIST IN GAS SPRINGS AND DAMPERS

GASSPRINGS.EU is the specialist in both standard and custom-made solutions for the manufacturing industry, focusing on gas springs, tension springs, and dampers. With many years of experience in the development, production, and sales of these components, GASSPRINGS.EU is a trusted partner in the field.

In addition to its extensive experience, GASSPRINGS.EU stands out for its strong engineering capabilities, always ensuring an optimal balance between expertise, price and quality. Thanks to in-house developed software, profound technical knowledge, and a practical approach, we are able to provide tailor-made solutions for a wide range of industrial challenges.

As a supplier of innovative and reliable products, GASSPRINGS.EU serves the European market. Renowned companies choose us for our proven quality and expertise, highlighting our commitment to customisation and customer-focused solutions.

QUALITY AND CUSTOMISATION

All gas springs supplied by GASSPRINGS.EU are manufactured in accordance with ISO 9001 and TS 16949 standards. With a wide range of products and customisation options, GASSPRINGS.EU delivers solutions for various technical challenges. Our technical advisors are ready to assist you in finding the most suitable solution.





LIFTING

Industrial gas springs are used in a wide variety of situations where a load must be moved in a controlled manner with minimal effort. Common applications include car tailgates, emergency and marine hatches, and machine covers, as well as sunbeds and caravans, all of which rely heavily on this technology. Gas springs ensure these systems operate smoothly and reliably.

LOCKING

For situations that require easy adjustment and positioning, lockable gas springs offer an ideal solution. They are widely used in office chairs, recliners, and medical applications such as hospital beds and wheelchairs. With a lockable gas spring, the user can easily adjust and stabilize every position.

DAMPING

To control and silently reduce motion, the hydraulic dampers from GASSPRINGS.EU provide an effective solution. These are used in kitchen cabinets, driver seats, and washing machines, as well as in belt tensioners and other mechanical systems where smooth damping is essential.



025

**CHAIR
COMPONENTS**



Your #NR 1 supplier of quality components for furniture and industry. **JUST ASK!**